



Vysoce slinuté neglazované jednobarevné dlaždice série Taurus COLOR jsou etalonem vysoké úrovně naší výroby. Nekompromisní kvalita, rozmanité povrchy dlaždic a technické doplňky umožňují použití obkladů nejen v moderních, nadčasových interiérech ale i prostorech, na které jsou kladeny vyšší funkční nároky. Součástí série jsou i keramické tvarovky pro slabozraké a nevidomé.

**„Harmonie bez limitů.“**



The highly sintered unglazed single-colour tiles of the Taurus COLOR series are the benchmark of our high level production. The uncompromising quality, variety of tile surfaces, and technical supplies allow the tiles to be used not only in modern, timeless interiors but also in spaces with higher functional requirements as well. The series also includes ceramic shaped bricks for the visually impaired and blind.









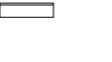

**„Harmony without limits.“**















výrobek   product								
EN 14411 - G B1a	<b>dlaždice  </b> floor tile	<b>dlaždice  </b> floor tile	<b>dlaždice  </b> floor tile	<b>dlaždice  </b> floor tile	<b>dlaždice  </b> floor tile	<b>mozaika set</b> <b>30×30 cm  </b> mosaic sheet 30×30 cm		
	<b>60×60 R</b>	<b>30×60 R</b>	<b>30×30</b>	<b>20×20</b>	<b>10×10</b>	<b>5×5 R</b>		
	598×598×10	298×598×10	298×298×9* <b>298×298×8**</b>	198×198×9* <b>198×198×8**</b>	98×98×9* <b>98×98×8**</b>	48×48×9* <b>48×48×8**</b>		
<b>povrch   surface</b>	SF* ABS	SF* ABS	SRU*	SF* ABS	relief SR7	S* ABS	SF* ABS	
<b>protiskluznost</b> slip resistance	R9/A <b>R10/B</b>	R9/A <b>R10/B</b>	R10/B	R9/A <b>R10/B</b>	R11/B	R10/A <b>R10/B</b>	<b>R10/B</b>	<b>R10/B</b>
<b>koefficient tření - za sucha</b> sliding friction coefficient	μ ≥ 0,6	μ ≥ 0,6	μ ≥ 0,6	μ ≥ 0,6	μ ≥ 0,7	μ ≥ 0,6	μ ≥ 0,6	μ ≥ 0,6
<b>barva   color</b>								
<b>19 Black</b> černá   black	TAA61019* <b>TAK63019**</b> ○ 88   m <sup>2</sup>	TAASA019* <b>TAKSE019**</b> ○ 84   m <sup>2</sup>	TRUSA019* ○ 86   m <sup>2</sup>	TAA35019* <b>TAA34019**</b> ○ 82   m <sup>2</sup>	TR735019* <b>TR734019**</b> ○ 84   m <sup>2</sup>	TAA26019* <b>TAA25019**</b> ○ 82   m <sup>2</sup>	TAA12019* <b>TAA11019**</b> ○ 90   m <sup>2</sup>	TDM06019* <b>TDM05019**</b> ○ 68   set
<b>07 Dark Grey</b> tmavě šedá dark grey	TAA61007* <b>TAK63007**</b> ○ 88   m <sup>2</sup>	TAASA007* <b>TAKSE007**</b> ○ 84   m <sup>2</sup>	TRUSA007* ○ 86   m <sup>2</sup>	TAA35007* <b>TAA34007**</b> ○ 78   m <sup>2</sup>	TR735007* <b>TR734007**</b> ○ 80   m <sup>2</sup>	TAA26007* <b>TAA25007**</b> ○ 80   m <sup>2</sup>	TAA12007* <b>TAA11007**</b> ○ 88   m <sup>2</sup>	TDM06007* <b>TDM05007**</b> ○ 68   set
<b>06 Grey</b> šedá   grey	TAA61006* <b>TAK63006**</b> ○ 88   m <sup>2</sup>	TAASA006* <b>TAKSE006**</b> ○ 84   m <sup>2</sup>	TRUSA006* ○ 86   m <sup>2</sup>	TAA35006* <b>TAA34006**</b> ○ 78   m <sup>2</sup>	TR735006* <b>TR734006**</b> ○ 80   m <sup>2</sup>	TAA26006* <b>TAA25006**</b> ○ 80   m <sup>2</sup>	TAA12006* <b>TAA11006**</b> ○ 88   m <sup>2</sup>	TDM06006* <b>TDM05006**</b> ○ 68   set
<b>03 Light Grey</b> světle šedá light grey	TAA61003* <b>TAK63003**</b> ○ 88   m <sup>2</sup>			TAA35003* <b>TAA34003**</b> ○ 82   m <sup>2</sup>	TR735003* <b>TR734003**</b> ○ 84   m <sup>2</sup>	TAA26003* <b>TAA25003**</b> ○ 82   m <sup>2</sup>	TAA12003* <b>TAA11003**</b> ○ 90   m <sup>2</sup>	TDM06003* <b>TDM05003**</b> ○ 68   set
<b>11 White</b> bílá   white	TAA61011* <b>TAK63011**</b> ○ 92   m <sup>2</sup>			TAA35011* <b>TAA34011**</b> ○ 86   m <sup>2</sup>		TAA26011* <b>TAA25011**</b> ○ 86   m <sup>2</sup>	TAA12011* <b>TAA11011**</b> ○ 94   m <sup>2</sup>	TDM06011* <b>TDM05011**</b> ○ 68   set
<b>10 Ivory</b> slonová kost ivory	TAA61010* <b>TAK63010**</b> ○ 88   m <sup>2</sup>			TAA35010* <b>TAA34010**</b> ○ 78   m <sup>2</sup>	TR735010* <b>TR734010**</b> ○ 80   m <sup>2</sup>	TAA26010* <b>TAA25010**</b> ○ 80   m <sup>2</sup>	TAA12010* <b>TAA11010**</b> ○ 88   m <sup>2</sup>	TDM06010* <b>TDM05010**</b> ○ 68   set
<b>25 Tobacco</b> hnědošedá brown-grey	TAA61025* <b>TAK63025**</b> ○ 88   m <sup>2</sup>			TAA35025* <b>TAA34025**</b> ○ 78   m <sup>2</sup>	TR735025* <b>TR734025**</b> ○ 80   m <sup>2</sup>	TAA26025* <b>TAA25025**</b> ○ 80   m <sup>2</sup>	TAA12025* <b>TAA11025**</b> ○ 88   m <sup>2</sup>	TDM06025* <b>TDM05025**</b> ○ 68   set
<b>logistická data   logistic information</b>								
	3	6		12   14	25   32	11   12	3   4	
	2,8	5,6		11,0   11,0	25,0   25,0	11,0   11,0	11,0   11,0	
	1,08	1,08		1,09   1,27	1,00   1,28	1,00   1,09	0,27   0,36	
	32	40		48   48	57   54	56   56	-	
	34,56	43,20		52,32   60,96	57,00   69,12	56,00   61,04	-	
	23,7	23,7		21,0   21,6	19,2   21,8	19,2   18,5	5,2   6,0	
	21,9	21,9		19,2   17,0	19,2   17,0	19,2   17,0	19,2   17,0	
	782	971		1 033   1 062	1 120   1 200	1 100   1 063	-	

\* Do vyprodání zásob | Available while stocks last  
 \*\* Nový produkt k dispozici od 05/2023 | New product available from 05/2023

výrobek   product							
STO č. 030-059824	<b>schodovka  </b> step tile	<b>schodový prvek s podstupnicí  </b> step piece with riser	<b>dlaždice - tvarovka  </b> special floor tile	<b>schodovka  </b> step tile	<b>sokl  </b> skirting plinth	<b>sokl  </b> skirting plinth	
	<b>30×60 R</b>	<b>60×5 R</b> <b>60×2</b>	<b>30×30</b>	<b>30×30</b>	<b>60×9,5 R</b>	<b>30×8</b>	
	298×598×10	598×50×10 598×20×10	298×298×9	298×298×9* <b>298×298×8**</b>	598×95×10	298×80×9* <b>298×80×8**</b>	
<b>povrch   surface</b>	SF* ABS 	SF* ABS 	relief go relief stop	SF* ABS 	SF* ABS 	S* ABS 	
<b>protiskluznost</b> slip resistance	R9/A R10/B	R9/A R10/B	R11/A	R11/A	R9/A R10/B		
<b>koeficient tření - za sucha</b> sliding friction coefficient	μ ≥ 0,7	μ ≥ 0,7	μ ≥ 0,7	μ ≥ 0,7	μ ≥ 0,7		
<b>barva   color</b>							
<b>19 Black</b> černá   black	TCPSA019* <b>TCPSE019**</b> ○ 72   ks	TCPVD019* <b>TCPVNO19**</b> ○ 76   set	TTG35019 ○ 78   ks	TTS35019 ○ 78   ks	TCP35019* <b>TCP34019**</b> ○ 44   ks	TSAS4019* <b>TSASZ019**</b> ○ 50   ks	TSAJB019* <b>TSAKF019**</b> ○ 19   ks
<b>07 Dark Grey</b> tmavě šedá dark grey	TCPSA007* <b>TCPSE007**</b> ○ 72   ks				TCP35007* <b>TCP34007**</b> ○ 44   ks	TSAS4007* <b>TSASZ007**</b> ○ 50   ks	TSAJB007* <b>TSAKF007**</b> ○ 19   ks
<b>06 Grey</b> šedá   grey	TCPSA006* <b>TCPSE006**</b> ○ 72   ks				TCP35006* <b>TCP34006**</b> ○ 44   ks	TSAS4006* <b>TSASZ006**</b> ○ 50   ks	TSAJB006* <b>TSAKF006**</b> ○ 19   ks
<b>03 Light Grey</b> šedá   light grey	TCPSA003* <b>TCPSE003**</b> ○ 72   ks				TCP35003* <b>TCP34003**</b> ○ 44   ks	TSAS4003* <b>TSASZ003**</b> ○ 50   ks	TSAJB003* <b>TSAKF003**</b> ○ 19   ks
<b>11 White</b> bílá   white	TCPSA011* <b>TCPSE011**</b> ○ 72   ks				TCP35011* <b>TCP34011**</b> ○ 46   ks	TSAS4011* <b>TSASZ011**</b> ○ 50   ks	TSAJB011* <b>TSAKF011**</b> ○ 19   ks
<b>10 Ivory</b> slonová kost ivory	TCPSA010* <b>TCPSE010**</b> ○ 72   ks	TCPVD010* <b>TCPVNO10**</b> ○ 76   set	TTG35010 ○ 78   ks	TTS35010 ○ 78   ks	TCP35010* <b>TCP34010**</b> ○ 44   ks	TSAS4010* <b>TSASZ010**</b> ○ 50   ks	TSAJB010* <b>TSAKF010**</b> ○ 19   ks
<b>25 Tobacco</b> hnědošedá brown-grey	TCPSA025* <b>TCPSE025**</b> ○ 72   ks				TCP35025* <b>TCP34025**</b> ○ 44   ks	TSAS4025* <b>TSASZ025**</b> ○ 50   ks	TSAJB025* <b>TSAKF025**</b> ○ 19   ks
<b>logistická data  </b> logistic information							
	6	16	9	11   13	13	21   23	
	5,6	-	11,0	11,0   11,0	17,5	42,0   42,0	
	1,08	-	0,81	1,00   1,18	0,74	0,50   0,55	
	40	-	42	52   52	-	-	
	43,20	-	34,36	52,00   61,36	-	-	
	23,7	15,2	18,0	19,2   19,5	16,2	9,5   9,4	
	21,9	21,9	22,2	19,2   17,0	21,9	19,0   17,0	
	971	-	780	1 024   1 039	-	-	

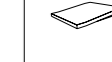
\* Do vyprodání zásob | Available while stocks last

\*\* Nový produkt k dispozici od 05/2023 | New product available from 05/2023

							
<b>sokl s požlábkem  </b> cove skirting	<b>sokl s požlábkem  </b> cove skirting	<b>vnitřní roh sokl s požlábkem  </b> inside corner cove skirting	<b>vnější roh sokl s požlábkem  </b> outside corner cove skirting	<b>vnitřní roh sokl s požlábkem  </b> inside corner cove skirting	<b>vnější roh sokl s požlábkem  </b> outside corner cove skirting	<b>bezbariérová tvarovka rohová  </b> shower piece corner	<b>bezbariérová tvarovka průběžná  </b> shower piece continuous
<b>30×8</b>	20×9 <b>20×8</b>	<b>2,3×8</b>	<b>2,3×8</b>	<b>2,3×9</b>	<b>2,3×9</b>	<b>10×10</b>	<b>10×10</b>
298×80×9* <b>298×80×8**</b>	198×90×9* <b>198×80×8**</b>	80×23×10	80×23×7	90×23×10	90×23×7	98×98×8	98×98×8
S* ABS 	S* ABS 	S	S	S*	S*	SB* ABS 	SB* ABS 
R10/B	R10/B					R10/B	R10/B
μ ≥ 0,6	μ ≥ 0,6					μ ≥ 0,6	μ ≥ 0,6
TSPJB019* <b>TSPKF019**</b> ○ 28   ks	TSPEM019* <b>TSPF6019**</b> ○ 22   ks	TSIRH019 ○ 46   ks	TSERH019 ○ 46   ks	TSIRB019* ○ 46   ks	TSERB019* ○ 46   ks	TTR12019* <b>TTR11019**</b> ○ 52   ks	TTP12019* <b>TTP11019**</b> ○ 52   ks
TSPJB007* <b>TSPKF007**</b> ○ 28   ks	TSPEM007* <b>TSPF6007**</b> ○ 22   ks	TSIRH007 ○ 46   ks	TSERH007 ○ 46   ks	TSIRB007* ○ 46   ks	TSERB007* ○ 46   ks	TTR12007* <b>TTR11007**</b> ○ 52   ks	TTP12007* <b>TTP11007**</b> ○ 52   ks
TSPJB006* <b>TSPKF006**</b> ○ 28   ks	TSPEM006* <b>TSPF6006**</b> ○ 22   ks	TSIRH006 ○ 46   ks	TSERH006 ○ 46   ks	TSIRB006* ○ 46   ks	TSERB006* ○ 46   ks	TTR12006* <b>TTR11006**</b> ○ 52   ks	TTP12006* <b>TTP11006**</b> ○ 52   ks
TSPJB003* <b>TSPKF003**</b> ○ 28   ks	TSPEM003* <b>TSPF6003**</b> ○ 22   ks	TSIRH003 ○ 46   ks	TSERH003 ○ 46   ks	TSIRB003* ○ 46   ks	TSERB003* ○ 46   ks	TTR12003* <b>TTR11003**</b> ○ 52   ks	TTP12003* <b>TTP11003**</b> ○ 52   ks
TSPJB010* <b>TSPKF010**</b> ○ 28   ks	TSPEM010* <b>TSPF6010**</b> ○ 22   ks	TSIRH010 ○ 46   ks	TSERH010 ○ 46   ks	TSIRB010* ○ 46   ks	TSERB010* ○ 46   ks	TTR12010* <b>TTR11010**</b> ○ 52   ks	TTP12010* <b>TTP11010**</b> ○ 52   ks
TSPJB025* <b>TSPKF025**</b> ○ 28   ks	TSPEM025* <b>TSPF6025**</b> ○ 22   ks	TSIRH025 ○ 46   ks	TSERH025 ○ 46   ks	TSIRB025* ○ 46   ks	TSERB025* ○ 46   ks	TTR12025* <b>TTR11025**</b> ○ 52   ks	TTP12025* <b>TTP11025**</b> ○ 52   ks
21   19	22   28	150	100	150	100	16	16
42,0   42,0	55,0   62,5	-	-	-	-	100,0	100,0
0,50   0,46	0,40   0,45	-	-	-	-	0,16	0,16
-	-	-	-	-	-	-	-
-	-	-	-	-	-	-	-
9,5   7,8	7,7   7,6	4,5	3,5	4,5	3,5	3,5	3,2
19,0   17,0	19,2   17,0	-	-	-	-	-	-
-	-	-	-	-	-	-	-



barvy | colors

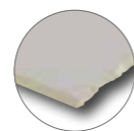

19 Black  
černá | black



07 Dark Grey  
tmavě šedá | dark grey



06 Grey  
šedá | grey



03 Light Grey  
světle šedá | light grey

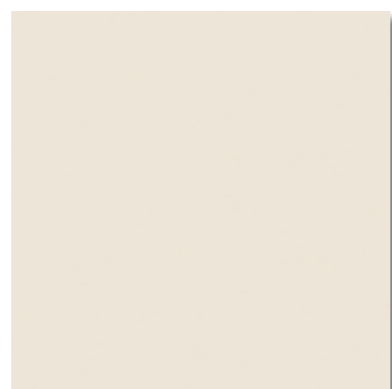

11 White  
bílá | white



10 Ivory  
slonová kost | ivory

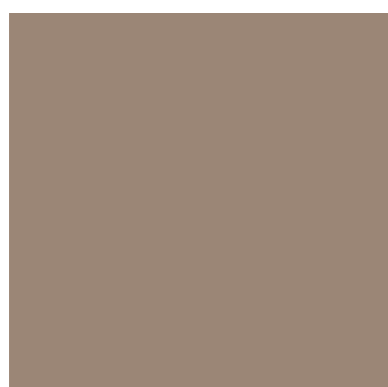

25 Tobacco  
hnědošedá | brown-grey



povrchy | surfaces



S | SF\* R9/A - R10/B  
 $\mu \geq 0,6 - 0,7$



SB\* R10/B  
 $\mu \geq 0,7$

ABS\*\* R10/B  
 $\mu \geq 0,6$  **News**



SRU\* R10/B  
 $\mu \geq 0,7$



relief SR7 R11/B  
 $\mu \geq 0,7$

S... - Standardní povrch | Standard surface  
SF... - Standardní povrch fixovaný | Standard surface fixed  
ABS... - Hladký protiskluzný povrch R10/B | Smooth slip-resistant surface R10/B  
SB... - Hladký protiskluzný povrch fixovaný | Smooth slip-resistant surface fixed  
SR... - Reliéfní povrch fixovaný | Relief surface

\* Do vyprodání zásob | Available while stocks last

\*\* Nový produkt k dispozici od 05/2023 | New product available from 05/2023

Barevné odstíny, které jsou zde vyobrazeny, mají pouze orientační charakter. | The colour shades shown are for orientation only.



doplňky | special pieces

**schodovka** | step tile | TCPSA... | 298×598×10 mm\*

**TCPSE... | 298×598×10 mm\*\*** |

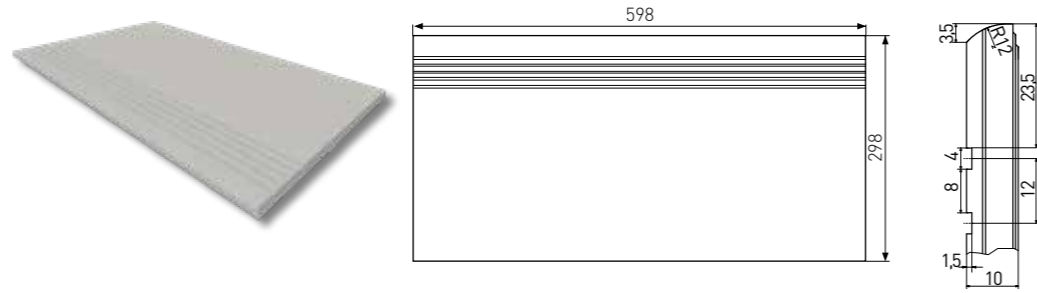

**schodovka** | step tile | TCP35... | 298×298×9 mm\*

**TCP34... | 298×298×8 mm\*\*** |

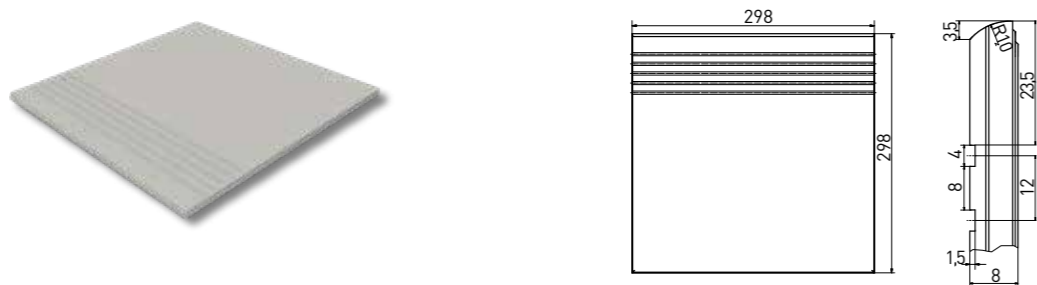

**sokl** | skirting plinth | TSAS4... | 598×95×10 mm\*

**TSASZ... | 598×95×10 mm\*\*** |

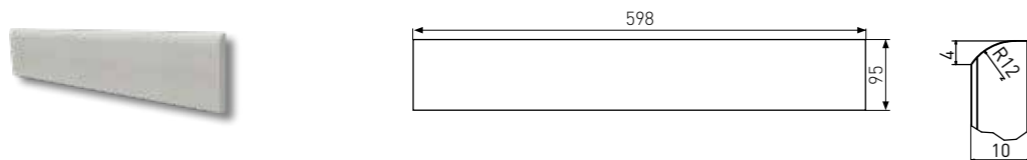

**sokl** | skirting plinth | TSAJB... | 298×80×9 mm\*

**TSAKF... | 298×80×8 mm\*\*** |

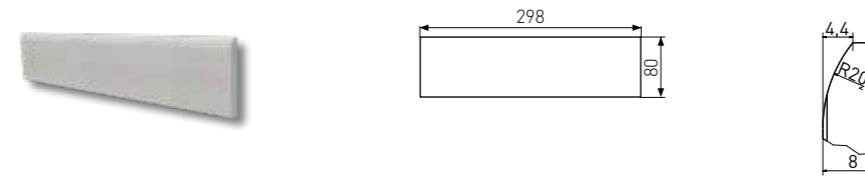

**sokl s požlábkem** | cove skirting | TSPJB... | 298×80×9 mm\*

**TSPKF... | 298×80×8 mm\*\*** |



**sokl s požlábkem** | cove skirting | TSP6M... | 198×90×9 mm\*

**TSPF6... | 198×80×8 mm\*\*** |

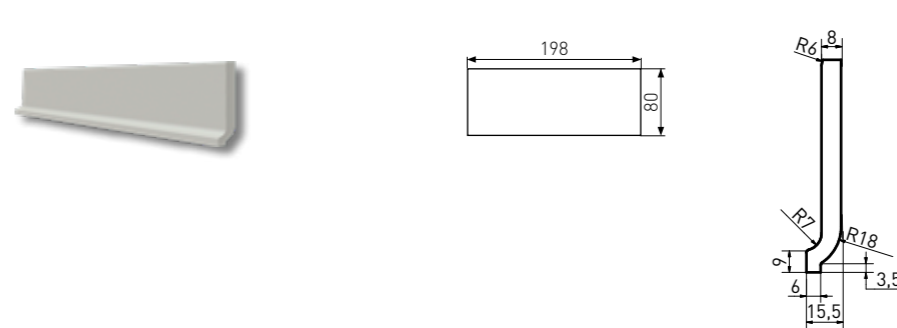

\* Do vyprodání zásob | Available while stocks last

\*\* Nový produkt k dispozici od 05/2023 | New product available from 05/2023



**vnitřní roh sokl s požlábkem** | inside corner cove skirting | TSIRH... | 80×23×10 mm

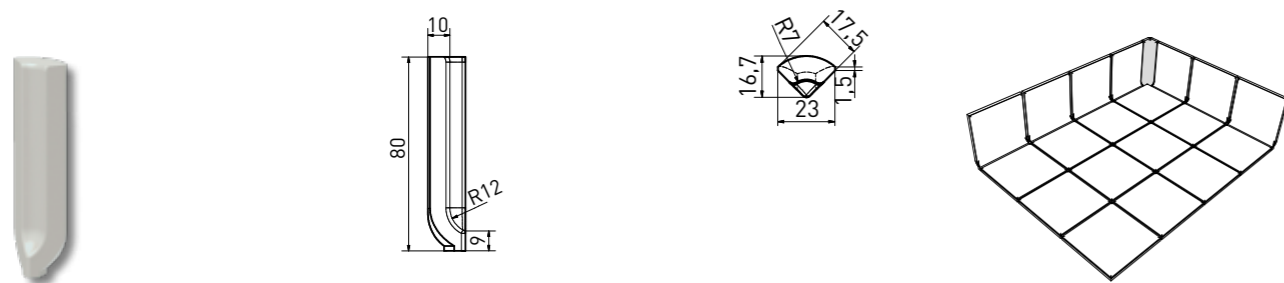

**vnější roh sokl s požlábkem** | outside corner cove skirting | TSERH... | 80×23×7 mm

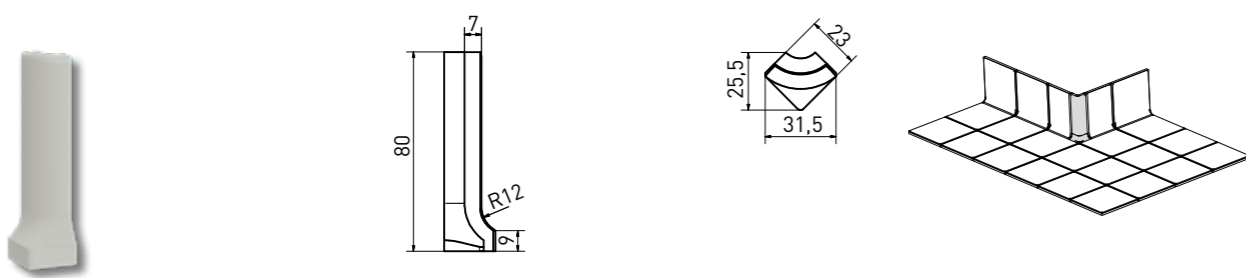

**vnitřní roh sokl s požlábkem** | inside corner cove skirting | TSIRB... | 90×23×10 mm\*

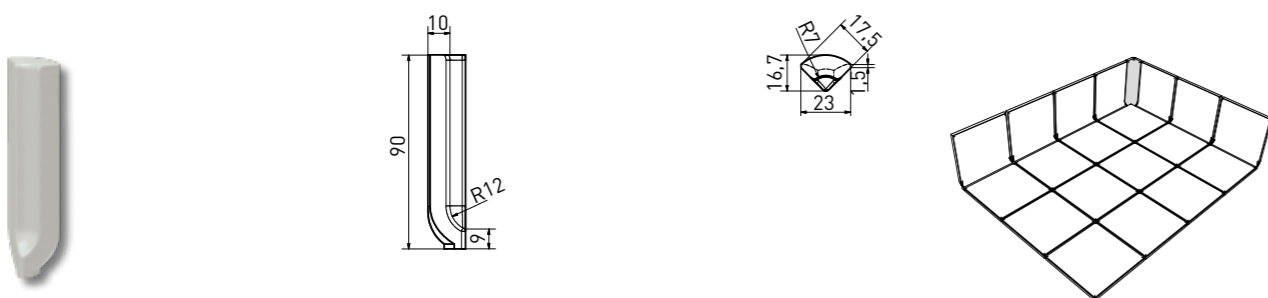

**vnější roh sokl s požlábkem** | outside corner cove skirting | TSERB... | 90×23×7 mm\*

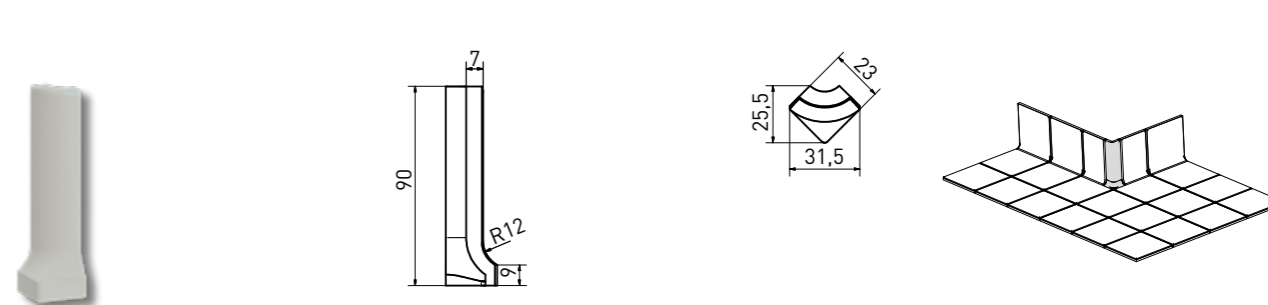

**bezbariérová tvarovka rohová** | shower piece - corner | TTR12... | 98×98×8 mm\*

**TTR11... | 98×98×8 mm\*\*** |

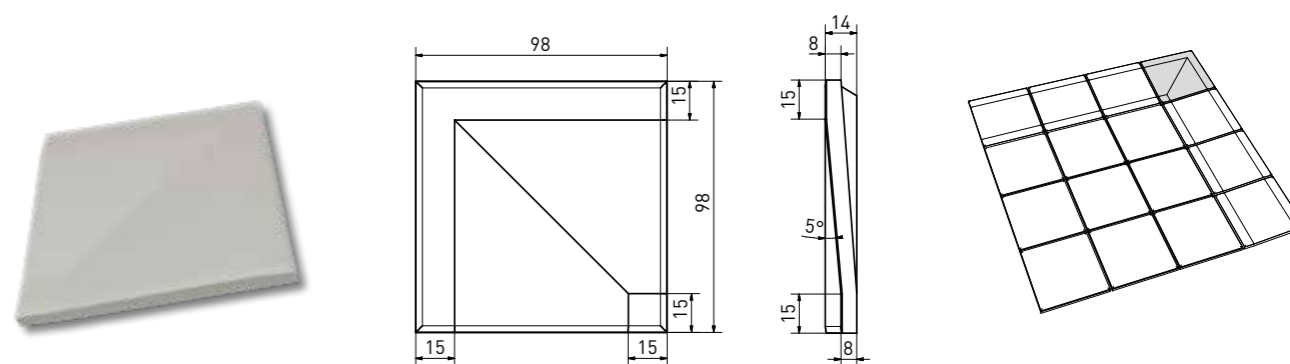

**bezbariérová tvarovka průběžná** | shower piece - continuous | TTP12... | 98×98×8 mm\*

**TTP11... | 98×98×8 mm\*\*** |

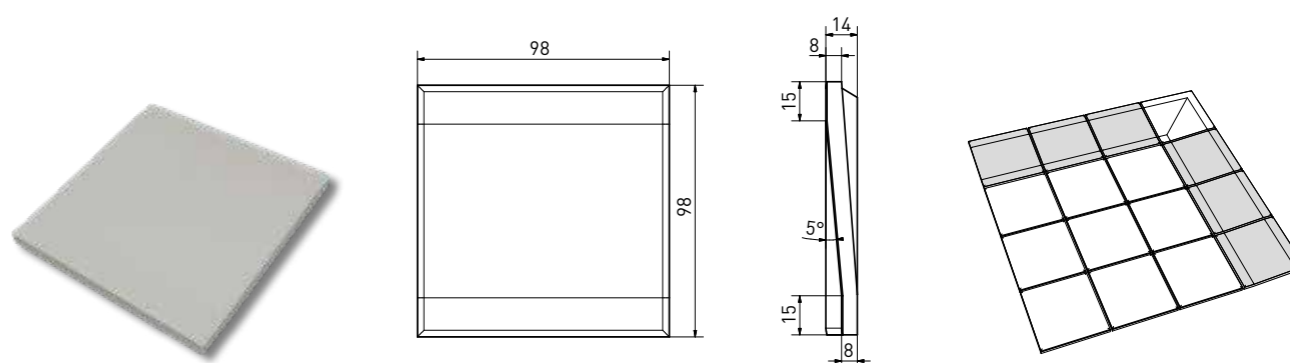

\* Do vyprodání zásob | Available while stocks last

\*\* Nový produkt k dispozici od 05/2023 | New product available from 05/2023





doplňky | special pieces



**schodový prvek s podstupnicí** | step piece with riser | TCPVD... | 598x50x10 mm | 598x20x10 mm\*

**TCPVN... | 598x50x10 mm | 598x20x10 mm\*\*** |

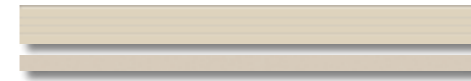

TCPVD010\*  
TCPVN010\*\*

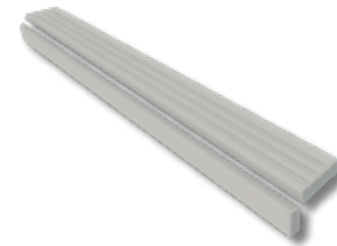

TCPVD019\*  
TCPVN019\*\*

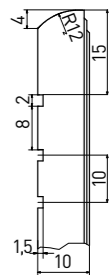
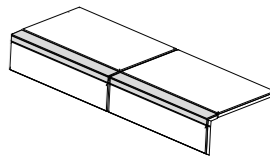
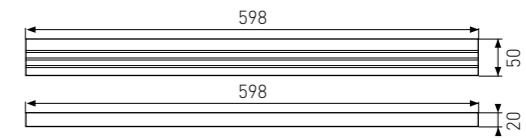

**speciální tvarovky pro nevidomé** | special ceramic shaped tiles for the visually impaired persons

relief go



TTG35010

12,8



TTG35019

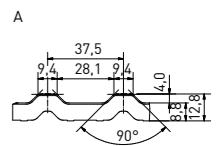

relief stop

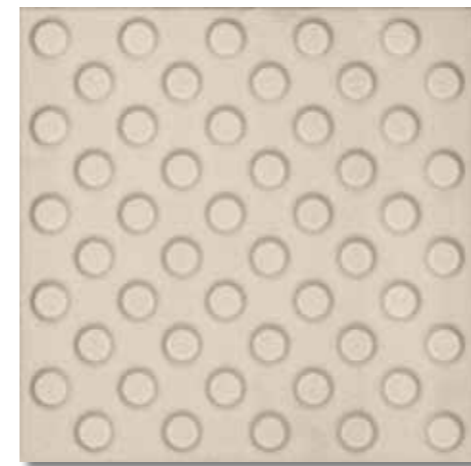

TTS35010

slonová kost | ivory

12,8

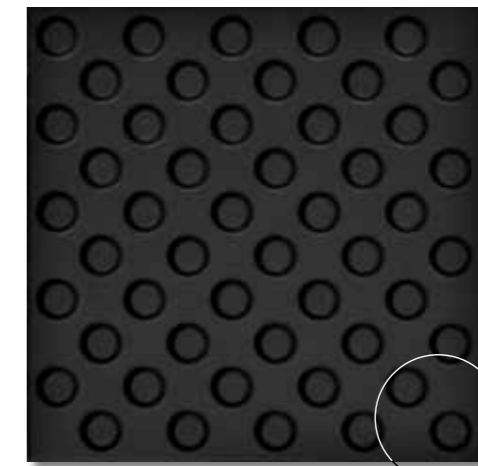

TTS35019

černá | black

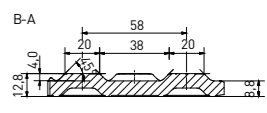
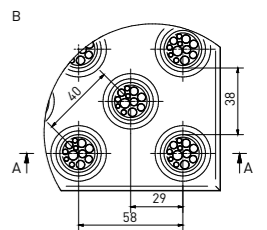

\* Do vyprodání zásob | Available while stocks last

\*\* Nový produkt k dispozici od 05/2023 | New product available from 05/2023