



TYPES / MODELS

ERGO

42V 200Hz

- (E) Manual del Operador
- (GB) Operators Manual
- (F) Manuel De L'Opérateur
- (S) Bruksanvisning
- (PL) Instrukcja Obsługi
- (RUS) Руководство для оператора
- (LT) Naudojimo Instrukcija
- (RO) Manual de Utilizare
- (NO) Betjening Håndbok
- (CZ) Na'vod K Obzluze
- (D) Bedienungshandbuch
- (BG) Оператор Ръчен



ER12/01



* MEDIO AMBIENTE * ENVIRONMENT * ENVIRONNEMENT * MILJÖ *
ŚRODOWISKO * ОКРУЖАЮЩЕЙ СРЕДЫ * APLINKA * MEDIU * MILJØ * ZIVOTNI
PROSTREDI * UMWELTSCHUTZ * ОКОЛНАТА СРЕДА *

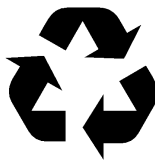

* SEGURIDAD GENERAL * GENERAL SAFETY * GENERALE DE SECURITE *
* ALLMÄN SÄKERHET * BEZPIECZEŃSTWA * ОБЩАЯ БЕЗОПАСНОСТЬ
* BENDROSIOS SAUGOS * SIGURANTA * GENERELL SIKKERHET * OBECNE
BEZPECNOSTNI POKYNY * ALLGEMEINE SICHERHEIT * ОБЩИ БЕЗОПАСНОСТ *



* AREA DE TRABAJO * WORK AREA * ZONE DE TRAVAIL *
ARBETSOMRADE * OBSZAR ROBOCZY * РАБОЧЕЕ МЕСТО * DARBO
VIETA * ZONA DE LUCRU * ARBEIDSOMRADE * PRACOVISTE *
ARBEITSUMFELD * РАБОТНОТО МЯСТО *



* QUICK VIEW * 

INTERRUPTOR
Switch

CLAVIJA CONEXION
Connection Plug

MANGUERA CAUCHO 1MT.
Rubber hose (1MT.)

BOTELLA VIBRADOR
Poker head vibrator

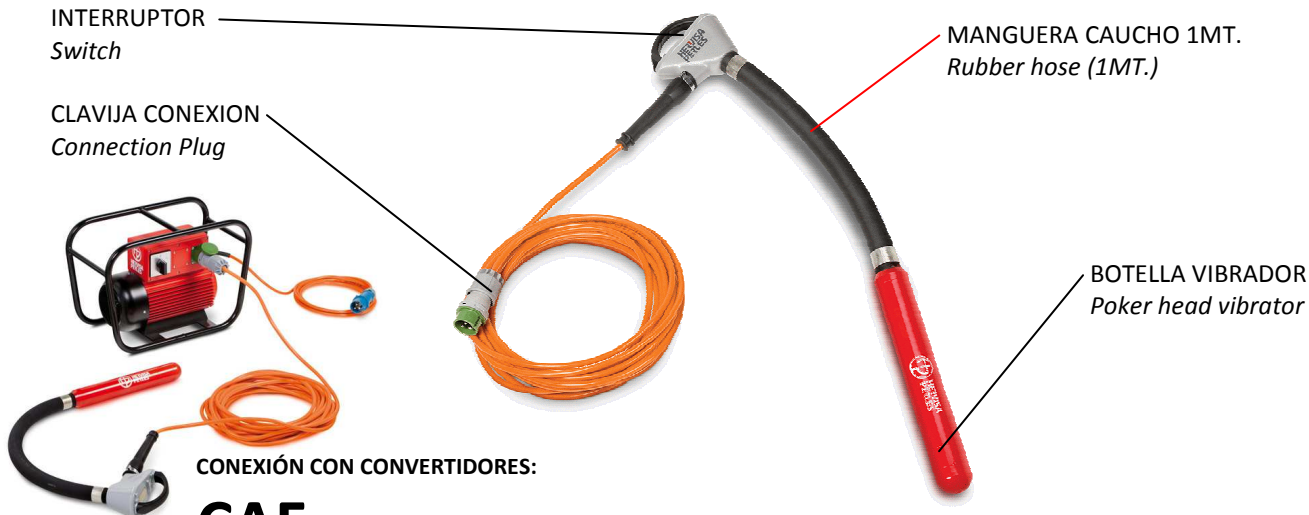

CONEXIÓN CON CONVERTIDORES:

CAF

* OPERATIVA * OPERATION * FONCTIONNEMENT * DRIFT
* PRACA URZADZENIA * РАБОЧИЕ * NAUDOJIMAS * UTILIZAREA * BRUK
* POKYNY PRO PROVOZ * HANDHABUNG * ОПЕРАТИВНА *

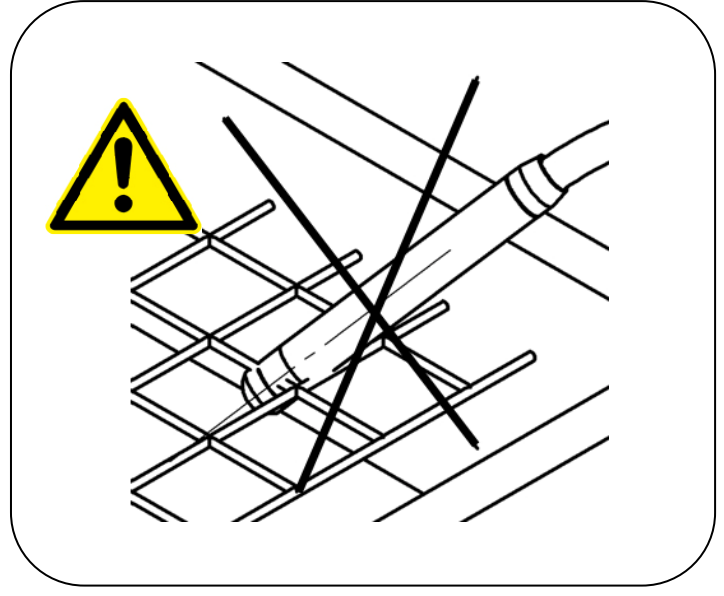
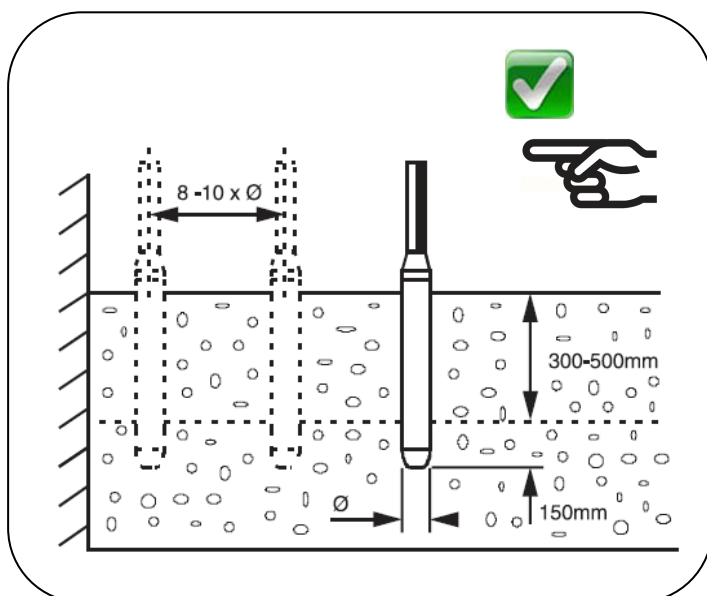
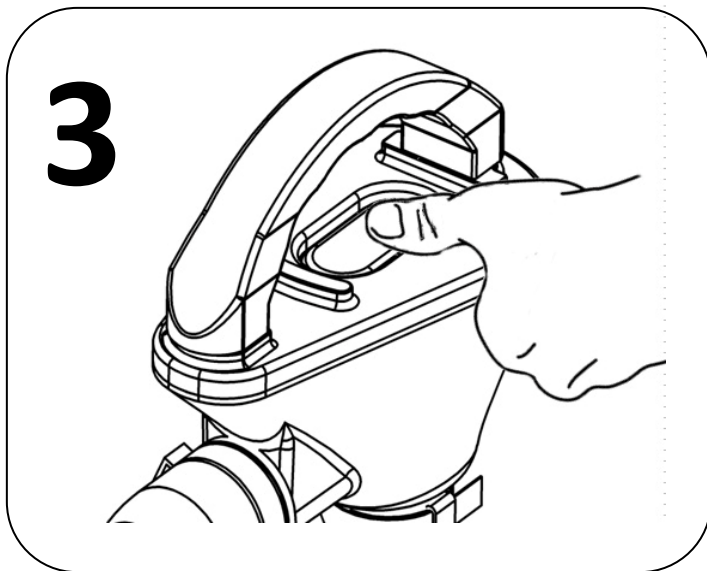
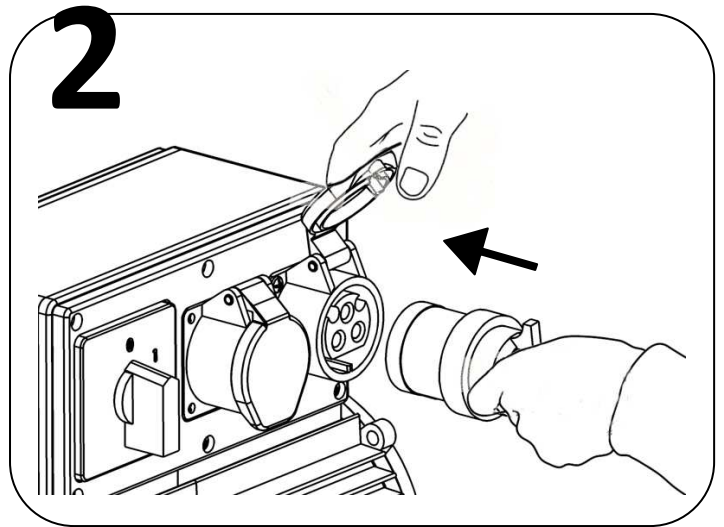
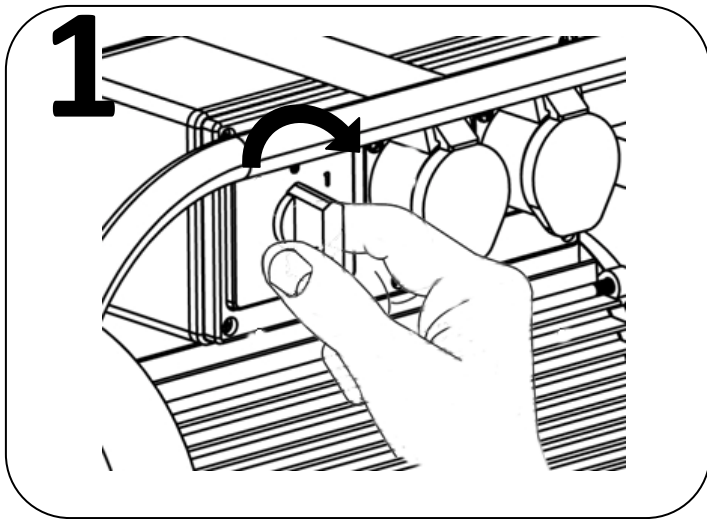

* SEGURIDAD ELECTRICA * ELECTRICAL SAFETY * SECURITE ELECTRIQUE *
 ELEKTRISK SAKERHET * BEZPIECZENSTWO ELEKTRYCZNE *
 ЭЛЕКТРИЧЕСКАЯ БЕЗОПАСНОСТЬ * DARBO SU ELEKTRINIAIS *
 SIGURANTA ELECTRIC * ELEKTRISK SIKKERHET * ELEKTRICKYM NARADIM
 * ELEKTRISCHE SICHERHEIT * ЕЛЕКТРИЧЕСКА БЕЗОПАСНОСТ *

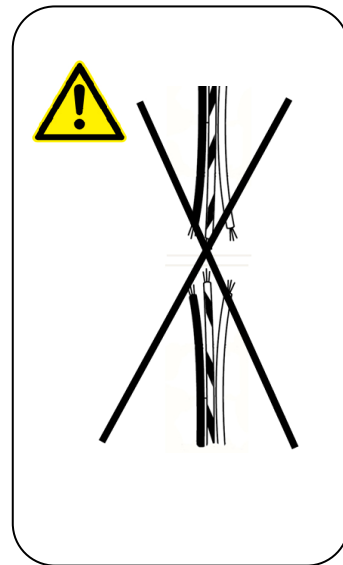
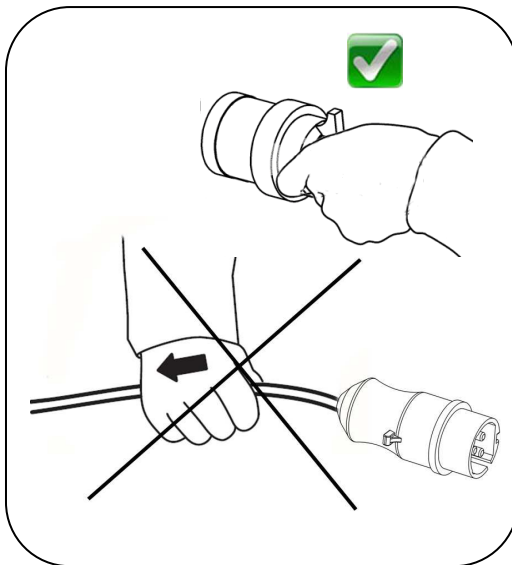
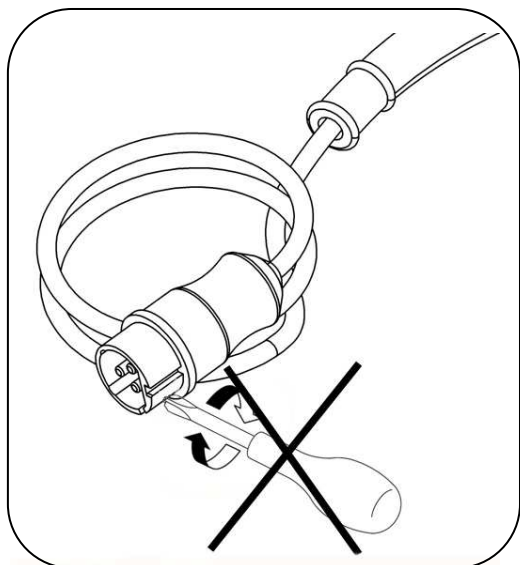

- *Precaución: Red con toma tierra
- *Warning: Grounding electrical network
- *Attention: Réseau électrique à la terre
- *Varning: Elnätet elektrisk jordning
- *Uwaga: Sieć elektryczna uziemienia
- *Внимание: сети электрического заземления
- *Atsargiai: Maitinimo elektros įžeminimo
- *Atenție: Rețea de împământare electrică
- *Advarsel: Stikkontakt grunnstøting
- *Upozornění: Napájecí elektrické uzemnění
- *Achtung: Netz elektrischen Erdung
- *Внимание: електрическата мрежа електрически заземяване

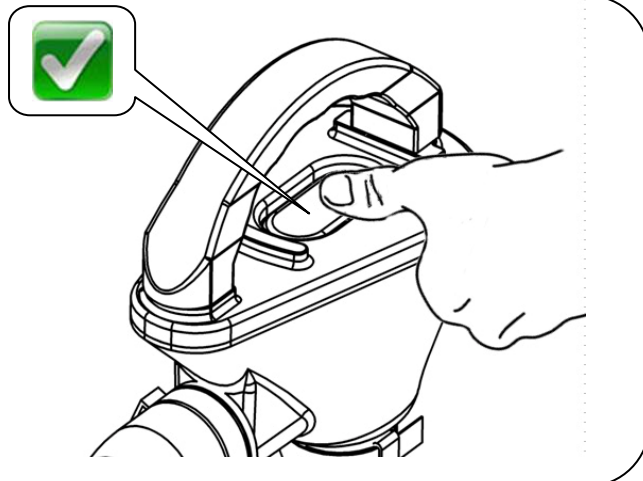

* SERVICIO Y MANTENIMIENTO * SERVICE AND MAINTENANCE * ENTRETIEN ET REVISION * SERVICE & UNDERHALL * SERWIS I KONSERWACJA * СЕРВИС И ОБСЛУЖИВАНИЕ * TECHNINE PRIEZIURA * SERVICE SI INTRETINERE * SERVICE OG VEDLIKEHOLD * SERVIS A UDRZBA * SERVICE AND WARTUNG * ОБСЛУЖВАНЕ И ПОДДЪРЖАНЕ *



grasa sintetica*synthetic grease*graisse synthétique*Syntetiskt fett*smaru syntetycznego*синтетическая смазка*sintetinis tepalas*sintetic unsoare*syntetiske fett*syntetický mazací tuk*synthetisches Fett*синтетични мазнини

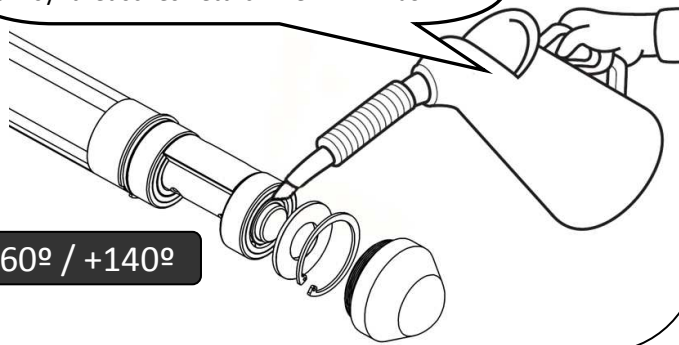

-60° / +140°

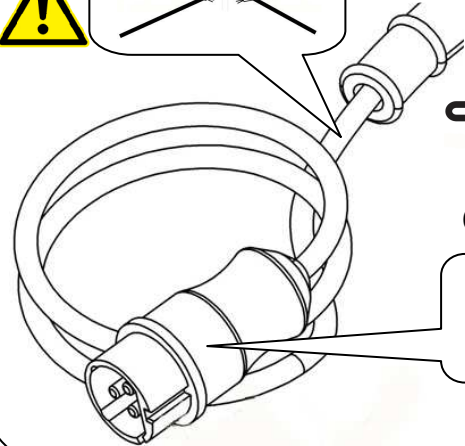
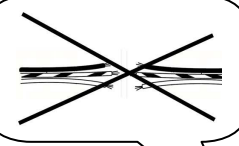

CHECK

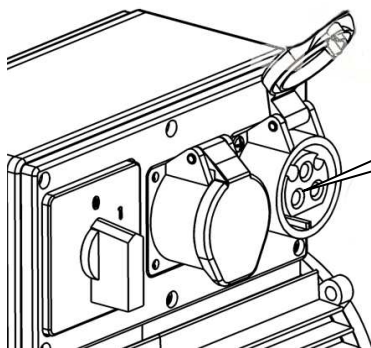

⚡ 3x42V
200Hz



CHECK

