



# User Manual

LiFePO<sub>4</sub> Energy Storage Battery

HV4850



## About This Document

This document describes the installation, electrical connections, commission, and troubleshooting of HV4850 High Voltage Energy Storage System (hereinafter referred as ESS). Before installing and operating the ESS, read this document carefully to understand the safety information as well as functions and features of the ESS.

This document is intended for:

- Technical support engineers
- Hardware installation engineers
- Commissioning engineers
- Maintenance engineers

# CONTENTS

About This Document.....	2
1 Safety Information.....	5
1.1 Personal Safety .....	6
1.2 Electrical Safety .....	7
1.3 Environment Requirements .....	9
1.4 Battery Safety .....	10
2 Product Description.....	14
2.1 Features.....	15
2.2 Components .....	15
2.2.1 Main Control Unit.....	16
2.2.2 Battery Module.....	17
3 Transportation and Storage.....	18
3.1 Transportation Requirements.....	18
3.2 Storage Requirements.....	19
4 System Installation .....	20
4.1 Checking Before the installation.....	20
4.2 Preparing tools and instruments.....	21
4.2.1 Tools .....	21
4.2.2 Fire-extinguisher system .....	21
4.3 Determining the Installation Position.....	21
4.3.1 Installation Environment Requirements .....	21
4.3.2 Installation Position Requirements .....	22
4.3.3 Installation Space Requirements.....	22
4.4 Equipment Installation .....	23
4.4.1 Battery module & Battery control unit installation.....	23

5	Electrical Connection.....	23
5.1	Internal Connections of the Battery .....	23
5.1.1	Installing an internal Ground Cable.....	23
5.1.2	Installing Internal communication cables.....	24
5.1.3	Installing internal DC Power cables.....	24
5.2	External Electrical Connections of the Battery.....	24
5.2.1	Installing an external BMS cable .....	24
5.2.2	Installing external DC power cable.....	24
5.3	Installing the Antenna .....	24
6	System Start Up .....	25
6.1	Verification Before Power-On .....	25
6.2	System Power-On .....	25
6.3	LED Indicator Instructions.....	26
7	System Maintenance .....	27
7.1	System Power-Off.....	27
7.2	Routine Maintenance .....	27
7.3	Troubleshooting .....	28
7.4	Replacement of main component.....	29
7.4.1	Replacement of battery module.....	29
7.4.2	Replacement of control Module (BMS).....	29
7.5	Battery Storage and Recharge.....	29
8	Emergency Handling.....	29
8.1	Batteries Leaking.....	29
8.2	Catching Fire.....	30
8.3	Soaking.....	31
8.4	Battery Falling or Strong Impact.....	31
9	Technical Specifications.....	31
10	System Debug.....	33

# 1 Safety Information

## Statement

Before transporting, storing, installing, operating, using, and/or maintaining the equipment, read this document, strictly follow the instructions provided herein, and follow all the safety instructions on the equipment and in this document. In this document, "equipment" refers to the products, software, components, spare parts, and/or services related to this document; "the Company" refers to the manufacturer (producer), seller, and/or service provider of the equipment; "you" refers to the entity that transports, stores, installs, operates, uses, and/or maintains the equipment.

The Danger, Warning, Caution, and Notice statements described in this document do not cover all the safety precautions. You also need to comply with relevant international, national, or regional standards and industry practices. The Company shall not be liable for any consequences that may arise due to violations of safety requirements or safety standards concerning the design, production, and usage of the equipment.

The equipment shall be used in an environment that meets the design specifications. Otherwise, the equipment may be faulty, malfunctioning, or damaged, which is not covered under the warranty. The Company shall not be liable for any property loss, personal injury, or even death caused thereby.

Comply with applicable laws, regulations, standards, and specifications during transportation, storage, installation, operation, use, and maintenance.

Do not perform reverse engineering, decompilation, disassembly, adaptation, implantation, or other derivative operations on the equipment software. Do not study the internal implementation logic of the equipment, obtain the source code of the equipment software, violate intellectual property rights, or disclose any of the performance test results of the equipment software.

## **The Company shall not be liable for any of the following circumstances or their consequences:**

- The equipment is damaged due to force majeure such as earthquakes, floods, volcanic eruptions, debris flows, lightning strikes, fires, wars, armed conflicts, typhoons, hurricanes, tornadoes, and other extreme weather conditions.
- The equipment is operated beyond the conditions specified in this document.
- The equipment is installed or used in environments that do not comply with international, national, or regional standards.
- The equipment is installed or used by unqualified personnel.
- You fail to follow the operation instructions and safety precautions on the product and in the document.
- You remove or modify the product or modify the software code without authorization.
- You or a third party authorized by you cause the equipment damage during transportation.
- The equipment is damaged due to storage conditions that do not meet the requirements specified in the product document.
- You fail to prepare materials and tools that comply with local laws, regulations, and related standards.

- The equipment is damaged due to your or a third party's negligence, intentional breach, gross negligence, or improper operations, or other reasons not related to the Company.

## **1.1 Personal Safety**

### **Danger**

Ensure that power is off during installation. Do not install or remove a cable with power on. Transient contact between the core of the cable and the conductor will cause electric arcs, sparks, fire or explosion, which may result in personal injury.

Non-standard and improper operations on the energized equipment may cause fire, electric shocks, or explosion, resulting in property damage, personal injury, or even death.

Before operations, remove conductive objects such as watches, bracelets, bangles, rings, and necklaces to prevent electric shocks.

During operations, use dedicated insulated tools to prevent electric shocks or short circuits. The dielectric withstanding voltage level must comply with local laws, regulations, standards, and specifications.

During operations, wear personal protective equipment such as protective clothing, insulated shoes, goggles, safety helmets, and insulated gloves.

### **General Requirements**

- Do not stop protective devices. Pay attention to the warnings, cautions, and related precautionary measures in this document and on the equipment.
- If there is a likelihood of personal injury or equipment damage during operations, immediately stop, report the case to the supervisor, and take feasible protective measures.
- Do not power on the equipment before it is installed or confirmed by professionals.
- Do not touch the power supply equipment directly or with conductors such as damp objects. Before touching any conductor surface or terminal, measure the voltage at the contact point to ensure that there is no risk of electric shock.
- Do not touch operating equipment because the enclosure is hot.
- In the case of a fire, immediately leave the building or the equipment area and activate the fire alarm or call emergency services. Do not enter the affected building or equipment area under any circumstances.

### **Personnel Requirements**

- Only professionals and trained personnel are allowed to operate the equipment.
  - Professionals: personnel who are familiar with the working principles and structure of the equipment, trained or experienced in equipment operations and are clear of the sources and degree of various potential hazards in equipment installation, operation, maintenance.
  - Trained personnel: personnel who are trained in technology and safety, have required experience, are aware of possible hazards on themselves in certain operations, and are able to take protective measures to minimize the hazards on themselves and other people.
- Personnel who plan to install or maintain the equipment must receive adequate training, be able to correctly perform all operations, and understand all necessary safety precautions and local relevant standards.

- Only qualified professionals or trained personnel are allowed to install, operate, and maintain the equipment.
- Only qualified professionals are allowed to remove safety facilities and inspect the equipment. Personnel who will perform special tasks such as electrical operations, working at heights, and operations of special equipment must possess the required local qualifications.
- Only certified high-voltage electricians are allowed to operate equipment.
- Only authorized professionals are allowed to replace the equipment or components (including software).
- Only personnel who need to work on the equipment are allowed to access the equipment.

## 1.2 Electrical Safety

### **Danger**

Before connecting cables, ensure that the equipment is intact. Otherwise, electric shocks or fire may occur.

Non-standard and improper operations may result in fire or electric shocks.

Prevent foreign matter from entering the equipment during operations. Otherwise, equipment damage, load power derating, power failure, or personal injury may occur.

### **WARNING**

For the equipment that needs to be grounded, install the ground cable first when installing the equipment and remove the ground cable last when removing the equipment.

### **General Requirements**

- Follow the procedures described in the document for installation, operation, and maintenance. Do not reconstruct or alter the equipment, add components, or change the installation sequence without permission.
- Obtain approval from the national or local electric utility company before connecting the equipment to the grid.
- Observe the power plant safety regulations, such as the operation and work ticket mechanisms.
- Install temporary fences or warning ropes and hang "No Entry" signs around the operation area to keep unauthorized personnel away from the area.
- Before installing or removing power cables, turn off the switches of the equipment and its upstream and downstream switches.
- If any liquid is detected inside the equipment, disconnect the power supply immediately and do not use the equipment.
- Before performing operations on the equipment, check that all tools meet the requirements and record the tools. After the operations are complete, collect all the tools to prevent them from being left inside the equipment.
- Before installing power cables, check that cable labels are correct and cable terminals are insulated.
- When installing the equipment, use a torque tool of a proper measurement range to tighten the screws. When using a wrench to tighten the screws, ensure that the wrench does not tilt, and the torque error does not exceed 10% of the specified value.

- Ensure that bolts are tightened with a torque tool and marked in red and blue after double □ checking. Installation personnel mark tightened bolts in blue. Quality inspection personnel confirm that the bolts are tightened and then mark them in red. (The marks must cross the edges of the bolts.)
- After the installation is complete, ensure that protective cases, insulation tubes, and other necessary items for all electrical components are in position to avoid electric shocks.
- If the equipment has multiple inputs, disconnect all the inputs before operating the equipment.
- Before maintaining a downstream electrical or power distribution device, turn off the output switch on the power supply equipment.
- During equipment maintenance, attach "Do not switch on" labels near the upstream and downstream switches or circuit breakers as well as warning signs to prevent accidental connection. The equipment can be powered on only after troubleshooting is complete.
- If fault diagnosis and troubleshooting need to be performed after power-off, take the following safety measures: Disconnect the power supply. Check whether the equipment is live.

Install a ground cable. Hang warning signs and set up fences.

- Check equipment connections periodically, ensuring that all screws are securely tightened.
- Only qualified professionals can replace a damaged cable.
- Do not scrawl, damage, or block any labels or nameplates on the equipment. Promptly replace labels that have worn out.
- Do not use solvents such as water, alcohol, or oil to clean electrical components inside or outside of the equipment.

### **Grounding**

- Ensure that the grounding impedance of the equipment complies with local electrical standards.
- Ensure that the equipment is connected permanently to the protective ground. Before operating the equipment, check its electrical connection to ensure that it is reliably grounded.
- Do not work on the equipment in the absence of a properly installed ground conductor.
- Do not damage the ground conductor.
- Ground the protective ground terminal on the equipment enclosure before connecting the power supply; otherwise, electric shock as a result of touch current may occur.

### **Cabling Requirements**

- When selecting, installing, and routing cables, follow local safety regulations and rules.
- When routing power cables, ensure that there is no coiling or twisting. Do not join or weld power cables. If necessary, use a longer cable.
- Ensure that all cables are properly connected and insulated and meet specifications.
- Ensure that the slots and holes for routing cables are free from sharp edges, and that the positions where cables are routed through pipes or cable holes are equipped with cushion materials to prevent the cables from being damaged by sharp edges or burrs.
- If a cable is routed into the cabinet from the top, bend the cable in a U shape outside the cabinet and then route it into the cabinet.



- Ensure that cables of the same type are bound together neatly and straight and that the cable sheath is intact. When routing cables of different types, ensure that they are at least 30 mm away from each other.
- When cable connection is completed or paused for a short period of time, seal the cable holes with sealing putty immediately to prevent small animals or moisture from entering.
- Secure buried cables using cable supports and cable clips. Ensure that the cables in the backfill area are in close contact with the ground to prevent cable deformation or damage during backfilling.
- If the external conditions (such as the cable layout or ambient temperature) change, verify the cable usage in accordance with the IEC-60364-5-52 or local laws and regulations. For example, check that the current-carrying capacity meets requirements.
- When routing cables, reserve at least 30 mm clearance between the cables and heat generating components or areas. This prevents deterioration or damage to the cable insulation layer.
- When the temperature is low, violent impact or vibration may damage the plastic cable sheathing. To ensure safety, comply with the following requirements:
  - Cables can be laid or installed only when the temperature is higher than 0°C. Handle cables with caution, especially at a low temperature.
  - Cables stored at subzero temperatures must be stored at room temperature for at least 24 hours before they are laid out.
- Do not perform any improper operations, for example, dropping cables directly from a vehicle.

Otherwise, the cable performance may deteriorate due to cable damage, which affects the current-carrying capacity and temperature rise.

### 1.3 Environment Requirements

#### **DANGER**

Do not expose the equipment to flammable or explosive gas or smoke. Do not perform any operation on the equipment in such environments.

Do not store any flammable or explosive materials in the equipment area.

Do not place the equipment near heat sources or fire sources, such as smoke, candles, heaters, or other heating devices. Overheat may damage the equipment or cause a fire.

#### **WARNING**

Install the equipment in an area far away from liquids. Do not install it under areas prone to condensation, such as under water pipes and air exhaust vents, or areas prone to water leakage, such as air conditioner vents, ventilation vents, or feeder windows of the equipment room. Ensure that no liquid enters the equipment to prevent faults or short circuits.

To prevent damage or fire due to high temperature, ensure that the ventilation vents or heat dissipation systems are not obstructed or covered by other objects while the equipment is running.

#### **General Requirements**

Ensure that the equipment is stored in a clean, dry, and well-ventilated area with proper

temperature and humidity and is protected from dust and condensation.

Keep the installation and operating environments of the equipment within the allowed ranges. Otherwise, its performance and safety will be compromised.

Do not install, use, or operate outdoor equipment and cables (including but not limited to moving equipment, operating equipment and cables, inserting connectors to or removing connectors from signal ports connected to outdoor facilities, working at heights, performing outdoor installation, and opening doors) in harsh weather conditions such as lightning, rain, snow, and level 6 or stronger wind.

Do not install the equipment in an environment with dust, smoke, volatile or corrosive gases, infrared and other radiations, organic solvents, or salty air.

Do not install the equipment in an environment with conductive metal or magnetic dust.

Do not install the equipment in an area conducive to the growth of microorganisms such as fungus or mildew.

Do not install the equipment in an area with strong vibration, noise, or electromagnetic interference.

Ensure that the site complies with local laws, regulations, and related standards.

Ensure that the ground in the installation environment is solid, free from spongy or soft soil, and not prone to subsidence. The site must not be located at a low-lying land prone to water or snow accumulation, and the horizontal level of the site must be above the highest water level of that area in history.

Do not install the equipment in a position that may be submerged in water.

If the equipment is installed in a place with abundant vegetation, in addition to routine weed-ing, harden the ground underneath the equipment using cement or gravel.

## **1.4 Battery Safety**

### **DANGER**

Do not connect the positive and negative poles of a battery together. Otherwise, the battery may be short circuited. Battery short circuits can generate high instantaneous current and releases a large amount of energy, which may cause battery leakage, smoke, flammable gas release, thermal runaway, fire or explosion. To avoid battery short circuits, do not maintain batteries with power on.

Do not expose batteries at high temperatures or around heat sources, such as scorching sunlight, fire sources, transformers, and heaters. Battery overheating may cause leakage, smoke, flammable gas release, thermal runaway, fire or explosion.

Protect batteries from mechanical vibration, falling, collision, punctures, and strong impact. Otherwise, the batteries may be damaged or catch fire.

To avoid leakage, smoke, flammable gas release, thermal runaway, fire or explosion, do not disassemble, alter, or damage batteries, for example, insert foreign objects into batteries, squeeze batteries, or immerse batteries in water or other liquids.

Do not touch battery terminals with other metal objects, which may cause heat or electrolyte leakage.

There is a risk of fire or explosion if the model of the battery in use or used for replacement is

incorrect. Use a battery of the model recommended by the manufacturer.

Battery electrolyte is toxic and volatile. Do not get contact with leaked liquids or inhale gases in the case of battery leakage or odor. In such cases, stay away from the battery and contact professionals immediately. Professionals must wear safety goggles, rubber gloves, gas masks, and protective clothing, power off the equipment, remove the battery, and contact technical engineers.

A battery is an enclosed system and will not release any gases under normal operations. If a battery is improperly treated, for example, burnt, needle-pricked, squeezed, struck by lightning, overcharged, or subject to other adverse conditions that may cause battery thermal runaway, the battery may be damaged or an abnormal chemical reaction may occur inside the battery, resulting in electrolyte leakage or production of gases such as CO and H<sub>2</sub>. To prevent fire or device corrosion, ensure that flammable gas is properly exhausted.

The gas generated by a burning battery may irritate your eyes, skin, and throat. Take protective measures promptly.

## **WARNING**

Install batteries in a dry area. Do not install them under areas prone to water leakage, such as air conditioner vents, ventilation vents, feeder windows of the equipment room, or water pipes. Ensure that no liquid enters the equipment to prevent faults or short circuits.

Before installing and commissioning batteries, prepare firefighting facilities, such as fire sand and carbon dioxide fire extinguishers, according to construction standards and regulations. Before putting into operation, ensure that firefighting facilities that comply with local laws and regulations are installed.

Before unpacking, storage, and transportation, ensure that the packing cases are intact and the batteries are correctly placed according to the labels on the packing cases. Do not place a battery upside down or vertically, lay it on one side, or tilt it. Stack the batteries according to the stacking requirements on the packing cases. Ensure that the batteries do not fall or get damaged. Otherwise, they will need to be scrapped.

After unpacking batteries, place them in the required direction. Do not place a battery upside down or vertically, lay it on one side, tilt it, or stack it. Ensure that the batteries do not fall or get damaged. Otherwise, they will need to be scrapped.

Tighten the screws on copper bars or cables to the torque specified in this document. Periodically confirm whether the screws are tightened, check for rust, corrosion, or other foreign objects, and clean them up if any. Loose screw connections will result in excessive voltage drops and batteries may catch fire when the current is high.

After batteries are discharged, charge them in time to avoid damage due to overdischarge.

## **Statement**

**The Company shall not be liable for any damage or other consequences to the batteries it provides due to the following reasons:**

- Batteries are damaged due to force majeure such as earthquakes, floods, volcanic eruptions, debris flows, lightning strikes, fires, wars, armed conflicts, typhoons, hurricanes, tornadoes, and other extreme weather conditions.

- Batteries are damaged because the onsite equipment operating environment or external power parameters do not meet the environment requirements for normal operation, for example, the actual operating temperature of batteries is too high or too low, or the power grid is unstable and experiences outages frequently.
- Batteries are damaged, fall, leak, or crack due to improper operations or incorrect connection.
- After being installed and connected to the system, the batteries are not powered on in time due to your reasons, which causes damage to the batteries due to overdischarge.
- Batteries are damaged because they are not accepted in time due to your reasons.
- You set battery operating parameters incorrectly.
- You use batteries of different types together, causing acceleration of capacity attenuation. For example, you use our batteries together with batteries of other vendors or with batteries of different rated capacity.
- You maintain batteries improperly, causing frequent overdischarge; you expand the load capacity without notifying us; or you have not fully charged the batteries for a long time.
- You do not perform battery maintenance based on the operation guide, such as failure to check battery terminals regularly.
- Batteries are damaged because you do not store them in accordance with storage requirements (for example, in an environment that is damp or prone to rain).
- Batteries are not charged as required during storage due to your reasons, resulting in capacity loss or other irreversible damages to the batteries.
- Batteries are damaged due to your or a third party's reasons, for example, relocating or reinstalling the batteries without complying with the Company's requirements.
- You change the battery use scenarios without notifying the Company.
- You connect extra loads to the batteries.
- The battery storage period has exceeded the upper limit.
- The battery warranty period has expired. You are advised not to use a battery whose warranty period has expired, as this poses safety risks.

### **General Requirements**

Before installing, operating, and maintaining batteries, read the battery instructions and comply with its requirements. The safety precautions specified in this document are highly important and require special attention.

Use batteries within the specified temperature range. When the ambient temperature of the batteries is lower than the allowed range, do not charge the batteries to prevent internal short circuits caused during low-temperature charging.

Before unpacking batteries, check whether the packaging is intact. Do not use batteries with damaged packaging. If any damage is found, notify the carrier and manufacturer immediately. Install batteries within 24 hours after unpacking. If the batteries cannot be installed in time, put them in the original packaging and place them in a dry indoor environment without corrosive gases. Power on the ESS within 24 hours after installation. The process from unpacking batteries to powering on the system must be completed within 72 hours. During routine maintenance, ensure that the power-off time does not exceed 24 hours.

Do not use a damaged battery (such as damage caused when a battery is dropped, bumped, bulged, or dented on the enclosure), because the damage may cause electrolyte leakage or flammable gas release. In the case of electrolyte leakage or structural deformation, contact the installer or professional O&M personnel immediately to remove or replace the battery. Do not store the damaged battery near other devices or flammable materials and keep it away from non-professionals.

Before working on a battery, ensure that there is no irritant or scorched smell around the battery.

When installing batteries, do not place installation tools, metal parts, or sundries on the batteries. After the installation is complete, clean up the objects on the batteries and the surrounding area.

Do not install battery packs on rainy, snowy, or foggy days. Otherwise, the battery packs may be corroded by moisture or rain.

If batteries are exposed to water accidentally, do not install them. Instead, transport the batteries to a safe isolation point and dispose of them in a timely manner.

Before installing battery packs, check whether they are abnormal. A battery pack is deemed abnormal when any of the following symptoms occurs:

- The enclosure of the battery pack is obviously deformed or damaged.
- The voltage between the positive and negative electrodes of the battery pack is far below the specified range.

Check whether the positive and negative battery terminals are grounded unexpectedly. If so, disconnect the battery terminals from the ground.

Do not perform welding or grinding work around batteries to prevent fire caused by electric sparks or arcs.

If batteries are left unused for a long period of time, store and charge them according to the battery requirements.

Do not charge or discharge batteries by using a device that does not comply with local laws and regulations.

Keep the battery loop disconnected during installation and maintenance.

Monitor damaged batteries during storage for signs of smoke, flame electrolyte leakage, or heat.

If a battery is faulty, its surface temperature may be high. Do not touch the battery to avoid scalds.

Do not stand on, lean on, or sit on the top of the equipment.

In backup power scenarios, do not use the batteries for the following situations:

- Medical devices substantially important to human life
- Control equipment such as trains and elevators, as this may cause personal injury
- Computer systems of social and public importance
- Locations near medical devices
- Other devices similar to those described above

### **Short-Circuit Protection**

When installing and maintaining batteries, wrap the exposed cable terminals on the batteries with insulation tape.

Avoid foreign objects (such as conductive objects, screws, and liquids) from entering a battery, as this may cause short circuits.

### **Leakage Handling**

Electrolyte is corrosive and can cause irritation and chemical burns. If you come into direct contact with the battery electrolyte, do as follows:

**Inhalation:** Evacuate from contaminated areas, get fresh air immediately, and seek immediate medical attention.

**Eye contact:** Immediately wash your eyes with water for at least 15 minutes, do not rub your eyes, and seek immediate medical attention.

**Skin contact:** Wash the affected areas immediately with soap and water and seek immediate medical attention.

**Intake:** Seek immediate medical attention.

### **Recycling**

Dispose of waste batteries in accordance with local laws and regulations. Do not dispose of batteries as household waste. Improper disposal of batteries may result in environmental pollution or an explosion.

If a battery leaks or is damaged, contact technical support or a battery recycling company for disposal.

If batteries are out of service life, contact a battery recycling company for disposal.

Do not expose waste batteries to high temperatures or direct sunlight.

Do not place waste batteries in environments with high humidity or corrosive substances.

Do not use faulty batteries. Contact a battery recycling company to scrap them as soon as possible to avoid environmental pollution.

### **Precaution**

Please read this manual carefully before installation and any operation.

Charge the battery every 6 months to keep battery SOC > 90% if long term storage.

Battery must be charged within 12 hours when low voltage alarm triggered.

Each Battery module has an output voltage of over 48V. It is vital to pay attention to personal safety in any case when operating.

All battery terminals must be disconnected before maintenance.

Please contact with Pytes or its dealer within 24 hours if there is anything abnormal.

Battery being damaged directly or indirectly by above cases will result in warranty failure.

## **2 Product Description**

HV4850 is a high voltage battery storage system based on lithium iron phosphate battery, which is one of the new energy storage products developed and produced by Pytes. By working with PCS (Power Conversion System), DC Chargers, Inverters and UPS etc., HV4850 can be applied in various scenarios including Micro-grid, Solar Energy Storage system, off-grid etc. It meets energy storage system demands for its long circle life, compact design, light weight, easy installation and wide compatibility with PCS.

HV4850 is equipped with built-in battery management system (BMS) to manage and monitor

voltage, current and temperature etc. of cells. The more important, HV4850 BMS is designed for balancing charging and discharging to prolong battery cycle life.

## 2.1 Features

Non-Toxic, Pollution Free and Environment Friendly

- Safe and Long Cycle Life
- Multi Protection Including over Charging/Discharging, over-Current and High/Low Temperature by Battery management system (BMS)
- Charge/Discharging State self-Management and Cell Voltage Capacity Balancing
- Flexible Configuration with Wide compatibility with Various PCS
- More Reliable and Little System Noise with Nature cooling
- Operation Temperature 0°C~55°C. Excellent Discharge Performance and Cycle Life
- Compact, Light Weight, Modular Design. Easy Installation, Maintenance and Replacement

## 2.2 Components

Note: This document uses the 19.2kWh system as an example. The actual structure may vary.

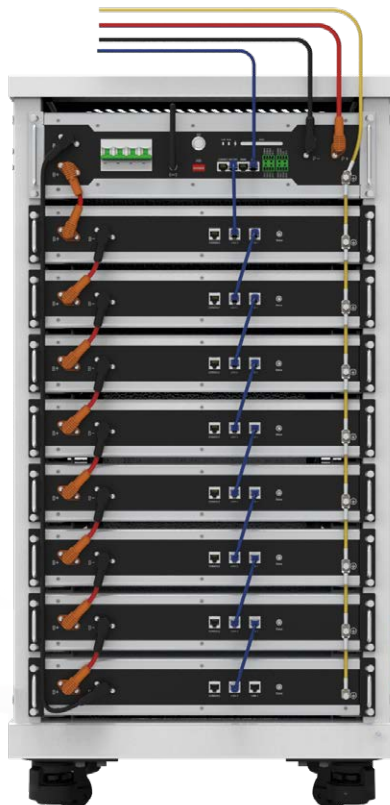

## 2.2.1 Main Control Unit

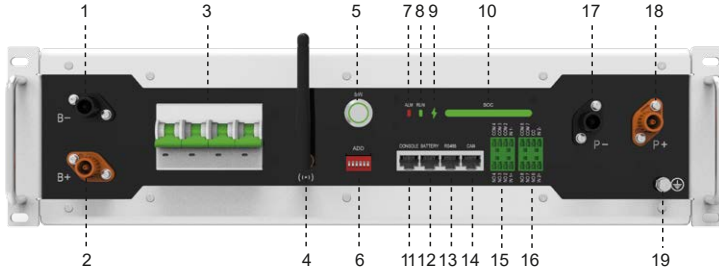

1	Battery Input Power(Negative)	To connect battery negative terminal
2	Battery Input Power (Positive)	To connect battery positive terminal
3	Circuit Breaker	Switch on/off battery power / protect the circuit from damage
4	Antenna Port	To connect WiFi Antenna
5	Soft Switch	Short press to turn on the system / Long Press to turn off the system
6	DIP Switch	Set DIP for different inverters
7	Alarm Indicator	Display start protection or system error
8	Run Indicator	Display system mode (Charging/Discharging/Standby)
9	SOC Indicator	Display remaining capacity
10	SOC Indicator	
11	Console Port	RJ45 port, following RS232 protocol
12	Battery Communication Port	To connect with battery module. RJ45 port, following CAN protocol
13	RS485 Port	To connect with inverter. RJ45 port
14	CAN Port	To connect with inverter. RJ45 port
15	Dry Contact - 1	Reserved
16	Dry Contact - 2	Reserved
17	DC Output Power (Negative)	To connect inverter negative terminal
18	DC Output Power (Positive)	To connect inverter positive terminal
19	Grounding Port	To connect grounding cable

## 2.2.2 Battery Module

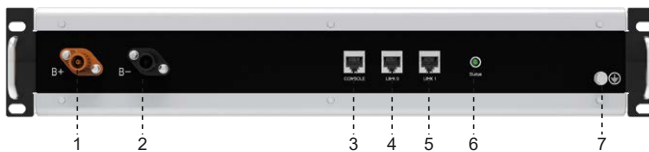

1	Battery Power Terminal (Positive)	To connect Battery in series
2	Battery Power Terminal (Negative)	To connect Battery in series



3	Console Port	RJ45 port, following RS232 protocol
4	Link 0 Port	RJ45 port, to connect to upper battery link 1 or BCU battery communication port.
5	Link 1 Port	RJ45 port, to connect to lower battery link 0 port.
6	RUN indicator	To show running status
7	Grounding Port	To connect grounding cable

## 3 Transportation and Storage

### 3.1 Transportation Requirements

#### **DANGER**

Load or unload batteries with caution. Otherwise, the batteries may be short circuited or damaged (such as leakage and crack), catch fire, or explode.

#### **WARNING**

Do not move a battery by holding its terminals, bolts, or cables. Otherwise, the battery may be damaged.

Keep batteries in the correct direction during transportation. They must not be placed upside down or tilted, and must be protected against falling, mechanical impact, rains, snows, and falling into water during transportation.

Before unpacking, storage, and transportation, ensure that the packing cases are intact, and the batteries are correctly placed according to the labels on the packing cases. Do not place a battery upside down or vertically, lay it on one side, or tilt it.

Stack the batteries according to the stacking requirements on the packing cases.

Ensure that the batteries do not fall or get damaged. Otherwise, they will need to be scrapped.

Battery module is pre-charged to 50% SOC or custom required before shipment. The remaining capacity will be determined by storage time and condition before installation on the scene.

1. The battery modules meet UN38.3 standard.

2. Comply with laws towards dangerous goods transportation, in particular, the revised ADR (European Convention on the International Carriage of Dangerous Goods by Road).

### 3.1 Storage Requirements

#### **WARNING**

Ensure that batteries are stored in a dry, clean, and ventilated indoor environment that is free from sources of strong infrared or other radiations, organic solvents, corrosive gases, and conductive metal dust. Do not expose batteries to direct sunlight or rain and keep them far away from sources of heat and ignition.

If a battery is faulty (with scorch, leakage, bulge, or water intrusion), move it to a dangerous goods warehouse for separate storage. The distance between the battery and any combustible materials must be at least 3 m. The battery must be scrapped as soon as possible.

Place batteries correctly according to the signs on the packing case during storage. Do not place batteries upside down, lay them on one side, or tilt them. Stack batteries in accordance with the stacking requirements on the packing cases.

Store the batteries in a separate place. Do not store batteries together with other devices. Do not stack batteries too high. If a large number of batteries are stored onsite, the site should be equipped.

### **CAUTION**

Batteries should be used soon after being deployed onsite. Batteries that have been stored for an extended period should be charged periodically. Otherwise, they may be damaged.

- The storage environment must comply with local regulations and standards.
- The storage environment must be clean and dry. The product must be protected against rain and water.
- The air must not contain corrosive or flammable gases.
- The storage environment requirements are as follows:
  - Ambient temperature: -20 - 45°C
  - Relative humidity: ≤75%
- If equipment except battery packs has been stored for more than two years, it must be checked and tested by professionals before use.
- Proof that the product is stored according to the requirements must be available, such as temperature and humidity log data, storage environment photos, and inspection reports.
- Ensure that batteries are delivered based on the "first in, first out" rule. Ensure that the storage duration starts from the latest charge time marked on the battery packing case and that the latest charge time is updated after every charge.

## **4 System Installation**

### **4.1 Checking Before the installation**

#### **Checking the Outer Packing**

Before unpacking the battery, check the outer packing for damage, such as holes and cracks, and check the battery model. If any damage is found or the battery model is not what you requested, do not unpack the product and contact your dealer as soon as possible.

#### **Checking Deliverables**

After unpacking the battery, check that the deliverables are intact and complete, and free from any obvious damage. If any item is missing or damaged, contact your dealer. For details about the number of deliverables delivered with the battery, see below packing list.







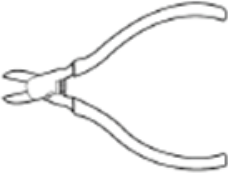
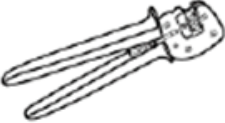

#### **Packing list**

Category	Item	Description	Quantity
BCU Package	Battery power cable-Positive	UL10269-6AWG-120mm-Orange-Amphenol 3.6mm terminals*2	1
	Battery power cable-Negative	UL10269-6AWG-870mm-Black-Amphenol 3.6mm terminals*2	1
	Output power cable-Positive	UL10269-6AWG-3000mm-3000-Orange-Amphenol 3.6mm terminal/SC16-6	1
	Output power cable-Negative	UL10269-6AWG-3000mm-3000-Black-Amphenol 3.6mm terminal/SC16-6	1
	Communication cable	CAT6 3500mm-RJ45*2	1
	Hex head screws	M5, cross recessed	1
	Communication cable Spare Connectors	RJ45	4
	Grounding cable	UL1015-8AWG-3000mm-Yellow/Green-SC10-5/SC10-6	2
	Antenna Parts	400-3C0819A02-002	1
	Antenna	HV40K---3D0203BK02-004-Black, Male Connector	1
	Hex head screws	M5, cross recessed	1

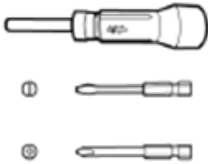
Category	Item	Description	Quantity
BMU Package	Battery power cable	UL10269-6AWG-140mm-Amphenol 3.6mm terminals*2	1
	Communication cable	CAT5e 220mm-RJ45*2	1
	Grounding cable	UL1015-8AWG-110mm-Yellow/Green-SC10-5	1
	Hex head screws	M5, cross recessed	4

## 4.2 Preparing tools and instruments

### 4.2.1 Tools

<b>Diagonal pliers</b>	<b>Crimping tool</b>	<b>Cable tie</b>
		
<b>Torque screwdriver</b>	<b>Torque wrench</b>	<b>Utility knife</b>
		
<b>Multimeter</b>	<b>Insulated gloves</b>	<b>Safety boots</b>
		

#### Notice

Use insulated tools to avoid electric shock or short circuits risks.

Alternatively, cover the entire exposing metal surface of tools with insulating tape if insulated tools are not available.

## 4.2.2 Fire-extinguisher system

The room where the system is installed must be equipped with fire extinguisher system. The fire-extinguisher system should be regularly checked to ensure normal condition.

Note: Refer to local requirements for using and maintenance.

## 4.3 Determining the Installation Position

### 4.3.1 Installation Environment Requirements

#### **WARNING**

HV4850 is IP20. It must be installed in a restricted location.

HV4850 is high voltage DC system, it must be operated by qualified and authorized professionals only.

#### **Cleaning**

The battery system is equipped with high voltage connectors. Cleaning conditions will affect isolation characteristic of the system. Before system installation and operation, dust and iron scurf must be cleaned. An anti-dust environment is recommended. Turn off the system to clean if it's over operation conditions.

#### **Operation Temperature**

HV4850 system Charging temperature: 0°C ~55°C

HV4850 system discharging temperature: -10°C ~55°C

#### **WARNING**

Out of operation temperature will lead to battery system over / low temperature alarm or protection, which reduces battery cycle life.

#### **Grounding system**

Make sure the system is well grounded before installation.

The resistance of the grounding system must  $\leq 100\text{m}\Omega$

#### **Installation Angle Requirement**

The battery can be floor-mounted only.

Do not install the battery at forward tilted, back tilted, side tilted, horizontal, or upside down positions.

### 4.3.2 Installation Position Requirements

Install the battery on a solid brick-concrete floor. If other types of floors are used, they must be made of fire-retardant materials and meet the load-bearing requirements of the equipment.

### 4.3.3 Installation Space Requirements

During installation, ensure that there are no other devices (except related Pytes devices and awnings) or flammable or explosive materials around the batteries. Reserve adequate space for heat dissipation and safety isolation.

Keep enough space for the batteries, recommended as below:

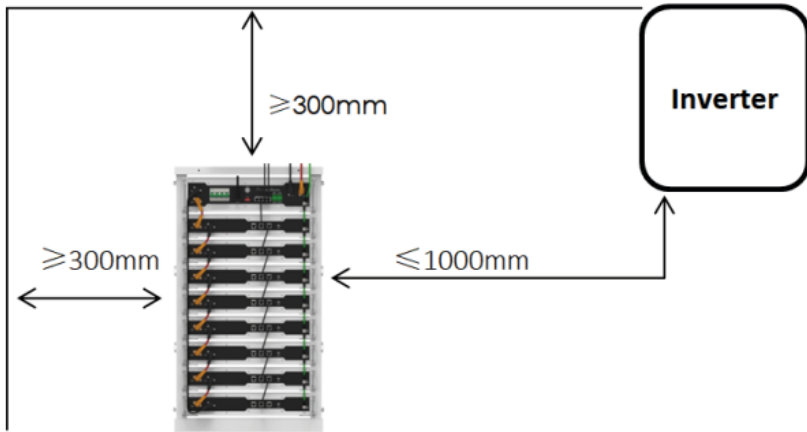

## 4.4 Equipment Installation

### 4.4.1 Battery module & Battery control unit installation

**Step 1** Place first Battery module onto bracket from the bottom, tighten 4 screws of mounting ear to fix the battery module to bracket.

**Step 2** Repeat Step 1 to install all battery modules in order from bottom to top.

**Step 3** Place Battery control unit onto bracket at the top, tighten 4 screws of mounting ear to fix the battery control unit on bracket.

Note: Single battery module is  $\geq 23$  kg. Be careful during whole procedure of handling and removal.

Note: The bracket filled with whole battery modules is  $\geq 237$ kg. Be cautious during whole procedure of handling and removal.

## 5 Electrical Connection

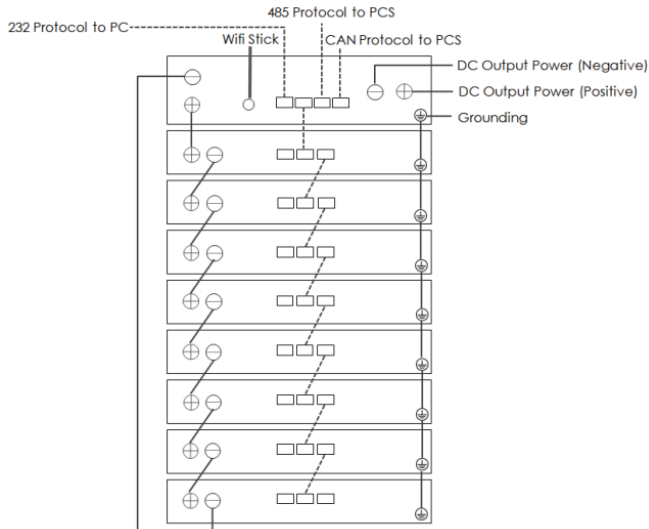

## 5.1 Internal Connections of the Battery

### 5.1.1 Installing an internal Ground Cable

#### Precautions

#### DANGER

Ensure that the PE Cable is securely connected. Otherwise, electric shocks may occur. It is recommended that silica gel or paint be used around the ground terminal after PE cable is connected.

**Step 1** Connect the PE cable to the cabinet ground point.

Note: The system grounding is achieved by cabinet grounding through metal surface direct touching of battery module, control module and rack/cabinet. If other cabinet is used, please make sure each battery is grounded.

### 5.1.2 Installing Internal communication cables

**Step 1** Connect the first battery negative terminal (B-) with second battery positive terminal (B+) with battery power cable.

**Step 2** Connect all battery modules in series by repeating Step 1 in order from top to bottom.

**Step 3** Connect the negative terminal (B-) of BCU with last battery negative terminal (B-) with negative battery power cable.

**Step 4** Connect the positive terminal (B+) of BCU with first battery positive terminal (B+) with positive power cable.

## 5.2 External Electrical Connections of the Battery

### 5.2.1 Installing an external BMS cable

**Step 1** Connect RS485/CAN port of BCU and Inverter BMS port with BMS cable.

Note:

Different Inverter will have different Communication protocol and Pin layout, consult installer for right one.

Port definition and Pin layout of BCU:

No.	CAN	RS485	RS232
1		485_B	
2		485_A	
3			TX
4	CAN_H		GND
5	CAN_L		
6			RX
7		485_A	
8		485_B	

### 5.2.2 Installing external DC power cable

**Step 1** Connect Negative External power terminal (P-) of BCU with inverter Negative Battery terminal (-).

**Step 2** Connect Positive External power terminal (P+) of BCU with inverter Negative Battery terminal (+).

## 5.3 Installing the Antenna

**Step 1** Connect the Antenna cable with WiFi Port on BCU.

## 6 System Start Up

### DANGER

Wear personal protective equipment and use dedicated insulated tools to avoid electric shocks or short circuits.

### WARNING

During Power-on procedure, power off the batteries immediately if any fault is detected. Rectify the fault before proceeding with the procedure.

After batteries are used for system commissioning or batteries have discharged, charge the batteries in time. Otherwise, batteries may be damaged due to over discharge.

Battery over discharge and damage may occur if batteries with low SOC are stored. Batteries should be recharged in a timely manner.

### NOTICE

Before the equipment is put into operation for the first time, ensure that the parameters are set correctly by professional personnel. Incorrect parameter settings may result in noncompliance with local grid connection requirements and affect the normal operations of the equipment.

## 6.1 Verification Before Power-On

Check items and acceptance criteria:

No.	Check Item	Acceptance Criteria
1	Battery installation	The installation is correct and reliable.
2	Cables Routing	Cables are routed properly as required by the customer.
3	Cable tie	Cable ties are evenly distributed, and noburr exists.
4	Grounding	The PE cable is connected correctly,securely, and reliably.
5	Switch	The DC switch and all switches connected to the battery are OFF.
6	Cable connection	The AC output power cable, DC input power cable, battery cable, and signal cables are connected correctly, securely, and reliably.
7	Unused terminal and port	Unused terminals and ports are locked by watertight caps.
8	Installation environment	The installation space is proper, and the installation environment is clean and tidy.



## 6.2 System Power-On

**Step 1** Set the right DIP according to corresponding PCS brand.

### DIP switch

code bit						PCS
1	2	3	4	5	6	
0	0	0	1	0	0	Afore
0	1	0	0	0	0	Deye
0	0	0	0	0	1	Hoymiles
0	0	0	0	1	0	Ingeteam
0	0	1	1	0	0	Luxpower
1	1	1	1	0	0	Megarevo
0	1	1	1	0	0	KEHUA
1	0	0	0	1	0	Solark
0	1	0	1	0	0	Solis
1	0	0	0	0	0	Voltronic

Notes: code bits 1, 2, 3, 4, 5, 6 in the schematic represent DIP switches from left to right facing front panel.

Dialing up = "1", Dialing down = "0".

Pytes may update PCS integration without further notice.

**Step 2** Turn on External Switch and inverter according to inverter guidance.

**Step 3** Turn on breaker on BCU.

**Step 4** Short press SW button on BCU, the RUN light will flash. All battery will start up.

## 6.3 LED Indicator Instructions

Battery status	Protection / Alarm / Normal	ALM	RUN	Capacity LED						Descriptions
		●	●	●	●	●	●	●	●	
Shut down		OFF	OFF	OFF	OFF	OFF	OFF	OFF	OFF	All off
Power-on	Normal	ON	ON	ON	ON	ON	ON	ON	ON	All lights on one second at same time.
Standby	Normal	OFF	Blink 1	OFF	OFF	OFF	OFF	OFF	OFF	Indication standby
	Alarm	Blink 3	OFF	OFF	OFF	OFF	OFF	OFF	OFF	Battery low voltage
Charging	Normal	OFF	Light	Based on capacity						Stop charging, protect start
	Alarm	Blink 3	Light	Based on capacity						
	Protection	Light	OFF	OFF	OFF	OFF	OFF	OFF	OFF	
Discharge	Normal	OFF	Blink 3	Base on capacity						Stop discharge, protect start
	Alarm	Blink 3	Blink 3	Base on capacity						
	Protection	Light	OFF	OFF	OFF	OFF	OFF	OFF	OFF	

Note: The blinking descriptions: Blink 1\*0.3s on/3.7s off"; Blink 2 \*0.5s on /0.5s off";Blink 3\*0.5s on / 1.5s off"; Blink 4\*0.7s on / 9.3s off"

## 7 System Maintenance

### DANGER

Wear personal protective equipment and use dedicated insulated tools to avoid electric shocks or short circuits.

Do not smoke or have an open flame around batteries.

Do not use wet cloth to clean exposed copper bars or other conductive parts.

Do not use water or any solvent to clean batteries.

### WARNING

Do not maintain batteries with power on. To power off the batteries before performing operations such as checking and tightening screw torques, explain the risks to the customer, obtain the customer's written consent, and take effective preventive measures.

After batteries are discharged, charge them in time to avoid damage due to over discharge.

Before moving or reconnecting the equipment, disconnect the mains and batteries and wait for five minutes until the equipment powers off. Before maintaining the equipment, check that no hazardous voltages remain in the DC bus or components to be maintained by using a multi-meter.

### CAUTION

Do not connect two or more cables to the positive or negative power port of a battery in parallel.

Stay away from the equipment when preparing cables to prevent cable scraps from entering the equipment. Cable scraps may cause sparks and result in personal injury and equipment damage.

### 7.1 System Power-Off

**Step 1** Turn off the AC switch between the inverter and the power grid.

**Step 2** Turn off the DC switch between battery and inverter.

**Step 3** Turn off the DC switch between PV and inverter.

**Step 4** Press SW button on BCU for 3 seconds. And wait for 20s for all battery shutdown.

**Step 5** Turn off breaker on BCU.

### CAUTION

Do not turn off the External power switch during system running.

Before battery module replacement service, charge/discharge the replaced battery to same voltage as the other modules in the system. Otherwise, it will take a long time for the system to balance the module.

### 7.2 Routine Maintenance

#### System Cleanliness

Check item	Check method	Maintenance interval
System cleanliness	Check periodically that cabinet are free from obstacles and dust.	Once every 6 to 12 months
System running status	Check that the battery is not damaged or deformed. Check that the battery parameters are correctly set when the battery is running.	Once every 6 months
Electrical Connection	Check that cables are secured. Check that cables are intact, and that in particular, the parts touching the metallic surface are not scratched. Check that unused DC input terminals, battery terminals, and other ports are locked by caps.	The first inspection is 6 months after the initial commissioning. From then on, the interval can be 6 to 12 months.
Grounding reliability	Check that ground cables are securely connected.	The first inspection is 6 months after the initial commissioning. From then on, the interval can be 6 to 12 months.

### 7.3 Troubleshooting

#### DANGER

HV4850 is a high voltage DC system, operated by qualified and authorized person only. Before checking the failure, make sure all cable connections and switches are in correct condition and the system can be turned on normally.

No.	Problem	Possible Reasons	Solution
1	Turn on the BMS. The Status LED lights in red. All battery module status LED Lights in green.	This battery string is under protection. It is possible Over Current Protection or Failure Protection. No external communication with upper controller.	Through the monitor or maintenance software check the battery cell, battery module has alarm or not. Check communication with upper controller and communication cable wiring. Reversed connection is seriously danger!
2	The BMS's Status LED is lighting red, and some the battery module's status LED is lighting green, but some is lighting red.	This battery string is under protection. It is possible Over Current, Over Voltage, Low Voltage, Over Temperature, Low Temperature or Failure Protection.	Use the monitor or maintenance software to check the battery cell, battery module has protection and failure or not.

## 7.4 Replacement of main component

### DANGER

HV4850 is a high voltage DC system, operated by qualified and authorized person only. The power cables and plugs always carry high voltage DC power from serial connected battery modules.

Be cautious to handle the power plugs.

### 7.4.1 Replacement of battery module

**Step 1** Use a charger to charge the new battery module and existing modules, both to full (SOC 100%);

**Step 2** Turn off the power of whole system. Make sure there's no power at P+ or P- terminals.

**Step 3** Pull out the Plugs of Power Cable +/- and communication cables.

**Step 4** Dismantle the 4 screws from front panel of battery module.

**Step 5** Handle the battery module out of the rack and put it in place.

**Step 6** Install the new battery module and connect the cables.

**Step 7** Power on the system by referring to chapter4.

### 7.4.2 Replacement of control Module (BMS)

**Step 1** Turn off the power of whole system. Make sure there's no power at P+ or P- terminals.

**Step 2** Pull out the Plugs of Power Cable +/- and communication cables.;

**Step 3** Dismantle the 4 screws from front panel of battery module.

**Step 4** Install the new control module (BMS) and reconnect all the cables.

**Step 5** Power on the system by referring to chapter4.

### CAUTION

Mark the cable numbers before pulling out the communication cables, to avoid cable wrong connection later.

## 7.5 Battery Storage and Recharge

For long-term storage, the battery cells should be stored in the environment with temperature range of -20°C ~45°C, relative humidity≤75% and no corrosive gas.

It is recommended to discharge and charge the battery every 3 months. The longest discharge and charge interval shall not exceed 6 months and SOC is charged to not less than 90% of each charging.

### CAUTION

If above instructions are not followed for long term storage, battery cycle life will significantly reduce.

## 8. Emergency Handling

### 8.1 Batteries Leaking

#### DANGER

The leaked electrolyte is a colorless viscous liquid that may evaporate rapidly and is flammable, turning into white salt residues. The electrolyte has a pungent smell and is corrosive, irritating to eyes and skin. Avoid contacting with it.

When handling chemical leakage incidents, professional maintenance personnel and firefighters must wear necessary protective equipment such as air-purifying respirator and other PPE. For household members, if battery leakage occurs, you are advised to follow the following steps:

(1) Stop the ESS immediately and set the battery power control module (DCDC) switch to OFF.

Turn off the AC circuit breaker of the inverter and set the inverter DC switch to OFF.

(2) Indoor installation scenario: Indoor personnel should quickly evacuate, open the doors, windows, and ventilation devices of the room, and turn off indoor fire sources during the evacuation. Outdoor installation scenario: Notify outdoor personnel to stay away from the site and set up a warning sign to isolate the area.

(3) After evacuating to a safe area, notify professional maintenance personnel or firefighters to handle the emergency.

Avoid contact with electrolytes or released gases. In the case of contact, take the following measures:

- Inhalation: Evacuate from contaminated areas, get fresh air immediately, and seek immediate medical attention.
- Eye contact: Immediately wash your eyes with water for at least 15 minutes, do not rub your eyes and seek immediate medical attention.
- Skin contact: Wash the affected areas immediately with soap and water and seek immediate medical attention.
- Intake: Seek immediate medical attention.

## 8.2 Catching Fire

### DANGER

In case of smoke or fire, if there is a large amount of smoke in the battery storage room, do not open the door to prevent explosion risks and toxic gas inhalation.

If a lithium battery catches fire, flammable and toxic gases will be released. Therefore, during the extinguishing process, all firefighters must wear a full set of protective suits, including flame retardant/fireproof clothing, air-purifying respirator or breathing apparatus, firefighter helmet and mask, and insulated shoes.

A lithium battery fire may last for several hours. After it is extinguished, the fire may be reignited by the heat generated from residual ingredients due to internal cell damage. After an open flame is extinguished, continue spraying water to cool the batteries. Wait until the battery temperature drops to the room temperature  $\pm 10^{\circ}\text{C}$  and monitor for 24 hours to ensure that there is no sign of temperature rise before removing the batteries. Move the removed batteries to a safe place (an open and safe outdoor place is recommended).

### Procedure

1. If batteries emit smoke or catch fires, notify all household members to evacuate immediately.
2. After evacuating to a safe outdoor area (20 m away is recommended), call the fire department immediately. While waiting for the fire rescue, contact the installer and Pytes technical support.

3. Firefighters arrive at the site and extinguish the fire.
4. After the fire is extinguished, set up a warning sign to isolate the area and spray water to reduce the battery temperature to the room temperature  $\pm 10^{\circ}\text{C}$ . (You can use an infrared thermometer or thermal imager.)
5. Observe the batteries for 24 hours and ensure that there is no sign of temperature rise before removing the batteries. (Only professionals are allowed to remove the batteries.)
6. After removing the batteries, move them to a safe place (an open and safe outdoor place is recommended), place them in the fire sand box or salt water. These operations must be performed by professionals who must take insulation measures, such as wearing insulated gloves, insulated shoes, and personal protective equipment (PPE).
7. After the battery fire is extinguished, if there is no potential risk onsite, the battery must be handled and recycled by professionals in accordance with local laws and regulations.

### 8.3 Soaking

If the battery pack is wet or submerged in water, cut off all power switches on inverter side, no further access. Contact Pytes or an authorized dealer for technical support.

### 8.4 Battery Falling or Strong Impact

#### DANGER

If a battery is dropped or violently impacted during installation, it may become faulty and cannot be used. Using a faulty battery will cause safety risks such as cell leakage and electric shock.

If a battery has obvious damage or abnormal odor, smoke, or fire occurs, evacuate the personnel immediately, call emergency services, and contact the professionals. The professionals can use fire extinguishing facilities to extinguish the fire under safety protection. If the appearance is not deformed or damaged, and there is no obvious abnormal odor, smoke, or fire, contact the professionals to transfer the battery to an open and safe place, or contact a recycling company for disposal.

## 9 Technical Specifications

<b>HV4850 System</b>	
Product	HV4850
Cell Type	LFP
Expansion	16
Nominal Energy	38.4KWH
Nominal Voltage	768VDC
Nominal Capacity	50Ah
Controller Model	HV4850 BCU
Battery Model	HV4850 BMU
Battery System Charging Voltage	852VDC

Discharging Cut-off Voltage	672VDC
Continuous Charging/Discharging Current	25A (0.5C)
Max Charging/Discharging Current	50A(1C)
Peak Discharging Current	100A@15S
Depth of Discharge	80%
Round-trip Efficiency	96%
External Communication	RS485/CAN/Dry Contact/Wifi
Monitoring Communication	RS232
Charging Temperature	0~55°C
Discharging Temperature	-10~55°C
Storage Temperature	-20~45°C
* Cycle Life	6000 Cycles
Warranty	10 Years
Rack Dimensions	W536mm*D513mm*H940mm
System Weight	381KG
Protection level	IP20
Heat Dissipation	Nature cooling
Certifications	CE/IEC62619/UN38.3

\* Test conditions 0.5C Charging/Discharging, @25°C, 80% DOD.

<b>Product</b>	<b>HV4850 BCU (Battery Control Unit)</b>
Voltage Range	200V~900V
Monitoring Communication	RS232
Battery Communication	RS485/CAN
External Communication	RS485/CAN/Dry Contact/WiFi
Dimensions	W440mm*D450mm*H120mm
Weight	13KG
Protection level	IP20

<b>Product</b>	<b>HV4850 BMU (Battery Module Unit)</b>
Cell Type	LFP
Expansion	5-16pcs
Nominal Energy	2.4KWH
Nominal Voltage	48VDC
Nominal Capacity	50Ah

Charging Voltage	53.25V
Discharging Cut-off Voltage	41.25V
Monitoring Communication	RS232
Battery Communication	RS485/CAN
Charging Temperature	0~55°C
Discharging Temperature	-10~55°C
Storage Temperature	-20~45°C
Round-trip Efficiency	96%
Cycle Life*	6000 cycles
Dimensions	W440mm*D450mm*H80mm
Weight	23KG
Protection level	IP20
Heat Dissipation	Nature cooling
Certifications	CE/IEC62619/UN38.3

WIFI Module	RF Band Range: 2.412GHz-2.472GHz
	Transmit power 802.11b: +17 +/-1.5dBm(@11Mbps); 802.11g: +15+/-1.5dBm(@54Mbps); 802.11n: +14+/-1.5dBm(@HT20, MCS7)
	Antenna Type: External WIFI Sticker, I-PEX to SMA 3dBi
	Gain: 3dBi

Remarks:

\* In case of 1C continuous charging and discharging, double check with PYTES for operation environment investigating is required. Improper conditions may trigger system protection.

\*\* 18°C~28°C operation temperature is suggested for best cycle performance purpose.



## 10 System Debug

Debug steps	Content
Preparation	<p>It is forbidden to turn on loads before turn on HV4850.</p> <p>Remarks: Follow instruction manuals of other equipment for turn on process other than HV4850.</p>
System Function	<p>Function Debug:</p> <p><b>Communication:</b> Check communication between HV4850 and devices, if it's normal or alarm.</p> <p><b>Power Conversion System:</b> Before conjoint, it is a must that PCS or Inverter System runs normally and parameters meet HV4850 requirement.</p> <p><b>System Operation:</b> Charge/Discharge, charging stop, discharging stop, current limiting, etc.</p> <p><b>Caution:</b> Set up all parameters of PCS and EMS before turn on HV4850.</p>
Monitor Function	<p>Connect to console terminal of main control to check whether data of HV4850 normally displays on the monitor system.</p>
Operation Trial	<p>After the system debugged, run the system a period with low load for trial operation, to test the high voltage DC system fits to requirement.</p>



**Shanghai PYTES Energy Co., LTD**

Add: No.3492 Jinqian Road, Fengxian District, Shanghai, China

Tel: +86 21 57475852

Email: [ess\\_support@pytesgroup.com](mailto:ess_support@pytesgroup.com)